

PORT WORKS DESIGN MANUAL

PART 1

General Design Considerations for Marine Works

**Civil Engineering Office
Civil Engineering Department
The Government of the Hong Kong Special Administrative Region**

© The Government of the Hong Kong Special Administrative Region

First published, May 2002

Continuously updated e-version, June 2023

Prepared by :

Civil Engineering Office,
Civil Engineering Department,
101 Princess Margaret Road,
Homantin, Kowloon, Hong Kong.

This Port Works Design Manual (PWDM) is a continuously updated version incorporating the PWDM Corrigenda issued since the PWDM was published. This continuously updated version is released in e-format only on the CEDD website. This PWDM is to be cited as “PWDM Part 1 (2023). General Design Considerations for Marine Works (Continuously updated e-version June 2023). Civil Engineering Office, Civil Engineering and Development Department, HKSAR Government.”

FOREWORD
(Continuously updated e-version Jun 2023)

This continuously updated e-version of the Port Works Design Manual has incorporated the previously issued Corrigenda No. 1/2014, No. 1/2018 and No. 1/2022 to facilitate the designers and industry practitioners to carry out coastal design in a more convenient manner.

Practitioners are encouraged to comment at any time to the Civil Engineering Office on the contents of this document, so that improvements can be made to future editions.



WONG Chi-pan, Ricky
Head, Civil Engineering Office
June 2023

FOREWORD

The Port Works Design Manual presents recommended standards and methodologies for the design of marine works in Hong Kong. It consists of five separate volumes, namely, Part 1 to Part 5. Part 1 mainly covers design considerations and requirements that are generally applicable to various types of marine works. Part 2 to Part 5 are concerned with specific design aspects of individual types of works including piers, dolphins, reclamation, seawalls, breakwaters and beaches. This Manual supersedes the Port Works Manual, of which the contents were prepared in the 80's.

This document, Port Works Design Manual : Part 1, gives guidance and recommendations on the general environmental, operational, geotechnical, loading, material, durability, maintenance and aesthetic considerations and criteria related to the design of marine works. It was prepared by a working committee comprising staff of the Civil Engineering Office and Special Duties Office with reference to the latest international and local marine works design standards, manuals and research findings in consultation with Government departments, engineering practitioners and professional bodies. Many individuals and organizations made very useful comments, which have been taken into account in drafting the document. An independent review was also undertaken by experts in relevant fields before the document was finalized. All contributions are gratefully acknowledged.

Practitioners are encouraged to comment at any time to the Civil Engineering Office on the contents of this document, so that improvements can be made to future editions.



C C Chan

Head, Civil Engineering Office

March 2002

Working Committee of Port Works Design Manual : Part 1 [First published Version in 2002]

The preparation of the document was overseen by Chief Engineer/Technical Services :

Ir Luk Fuk-man (before 3 December 2001)

Ir Anthony Loo

The document was drafted by the following staff of the Civil Engineering Office :

Ir Lee Wai-ping

Ir Li Kam-sang

Ir Wong Chi-pan

Assistance and advice were provided by the following staff of the Civil Engineering Office and Special Duties Office :

Ir Chiu Mau-fat

Ir Ko Wai-kuen

Ir Lai Cheuk-ho (before 12 September 2001)

Ir Lam Chi-keung

Ir Law Man-chin

Ir Li Yuen-wing

The document was reviewed by :

Professor Yoshimi Goda, Yokohama National University

Professor Lee Chack-fan, the University of Hong Kong

Dr Kwan Kwok-hung, the University of Hong Kong

Extracts from British Standards are reproduced with the permission of British Standards Institution (BSI) under licence number 2001/SK0316. British Standards can be obtained from BSI Customer Services, 389 Chiswick High Road, London W4 4AL, United Kingdom (Tel +44 20 8996 9001). Figures in Appendix A are reproduced from “Random Seas and Design of Maritime Structures” with the permission of Professor Yoshimi Goda.

CONTENTS

	Page No.
TITLE PAGE	1
FOREWORD	3
CONTENTS	6
1. INTRODUCTION	11
1.1 Purpose and Scope	11
1.2 Definitions, Symbols and References	12
2. ENVIRONMENTAL CONSIDERATIONS	13
2.1 General	13
2.2 Tide and Water Levels	13
2.2.1 Datum	13
2.2.2 Tidal Characteristics in Hong Kong	13
2.2.3 Mean Water Levels	14
2.2.4 Extreme Water Levels	14
2.2.5 Rise in Sea Levels due to Climate Change	15
2.2.6 Storm Surge Increase due to Climate Change	15
2.3 Bathymetry	16
2.4 Wind	16
2.4.1 Wind Stations in and around Hong Kong	16
2.4.2 Extreme Wind Speeds	17
2.4.3 Directional Distribution of Wind	18
2.4.4 Increase in Extreme Wind Speeds due to Climate Change	18
2.5 Waves Generated by Winds	19
2.5.1 General	19
2.5.2 Wave Characteristics	19
2.5.3 Wave Parameters	21
2.5.4 Wave Conditions in Hong Kong	24
2.5.5 Wave Data and Data Sources	26
2.5.6 Wind Data for Wave Prediction	28
2.5.7 Wave Prediction from Wave Measurement	29
2.5.8 Wave Prediction by Mathematical Modelling	29
2.5.9 Wave Breaking in Surf Zone	32
2.5.10 Use of Physical Wave Modelling	32

	Page No.
2.5.11 Wave Overtopping	33
2.6 Ship Waves in Harbour	33
2.7 Currents	34
2.7.1 General	34
2.7.2 Field Measurements	34
2.7.3 Current Prediction by Mathematical Modelling	35
2.7.4 Use of Physical Flow Modelling	38
2.8 Sediments	38
2.9 Design Allowance with Progressive Adaptive Approach to Enhance Climate Resilience	39
2.10 Increase in Design Extreme Sea Level due to Climate Change Effect	41
 3. OPERATIONAL CONSIDERATIONS	 42
3.1 General	42
3.2 Design Life	42
3.3 Ship Data	43
3.4 Current Conditions	43
3.5 Berth Conditions	44
3.6 Typhoon Shelters	44
3.7 Approach Channels	44
3.8 Navigation Aids	45
3.9 Critical Infrastructure	46
 4. GEOTECHNICAL CONSIDERATIONS	 47
4.1 General	47
4.2 Marine Geology and Characteristics	47
4.3 Determination of Soil Properties	50
4.4 Determination of Rock Properties	53
 5. LOADING CONSIDERATIONS	 54
5.1 General	54
5.2 Loading Conditions and Combinations	55
5.2.1 Normal Loading Conditions	55
5.2.2 Extreme Loading Conditions	56
5.2.3 Temporary Loading Conditions	57
5.2.4 Accident Loading Conditions	57
5.3 Dead Loads	58
5.4 Superimposed Dead Loads	58

	Page No.
5.5 Live Loads	58
5.5.1 Live Loads on Different Types of Structures	58
5.5.2 Determination of Continuous Live Loads	60
5.6 Tides and Water Level Variations	60
5.7 Hydrostatic Loads	61
5.8 Soil Pressure and Ground Water Profiles	62
5.9 Wind Loads	63
5.10 Wave Loads	64
5.10.1 General	64
5.10.2 Wave Conditions	65
5.10.3 Wave Forces on Vertical Structures	67
5.10.4 Wave Forces on Piles	68
5.10.5 Wave Forces on Pile-supported Deck Structures	69
5.10.6 Wave Uplift	69
5.10.7 Waves on Rubble Mound Structures	70
5.11 Current Loads	70
5.11.1 General	70
5.11.2 Steady Drag Forces	71
5.11.3 Flow Induced Oscillations	72
5.12 Berthing Loads	72
5.12.1 General	72
5.12.2 Assessment of Berthing Energy	73
5.12.3 Berthing Reactions	75
5.13 Mooring Loads	76
5.14 Temperature Variation	77
5.15 Earthquakes, Movements and Vibrations	77
 6. CONSTRUCTION MATERIALS AND DURABILITY	 79
6.1 General	79
6.2 Reinforced Concrete	79
6.3 Unreinforced Concrete	80
6.4 Underwater Concrete	80
6.5 Steel	81
6.5.1 Structural Steel in General	81
6.5.2 Corrosion Protection	81
6.5.3 Use of Stainless Steel	81
6.5.4 General Guidance	82
6.6 Timber	82
6.7 Rubber	83
6.8 Protective Measures	83

	Page No.
6.8.1 General	83
6.8.2 Protective Coatings for Steel	83
6.8.3 Protective Coatings for Concrete	84
6.8.4 Cathodic Protection for Reinforced Concrete	85
6.8.5 Corrosion Protection of Steel Tubular Piles	85
6.8.6 Corrosion Monitoring	86
6.8.7 Important Points to be Considered	87
6.9 Armour Rock	87
6.10 Fill	88
 7. MAINTENANCE	 91
7.1 General	91
7.2 Design Considerations	91
7.3 Maintenance Facilities	92
7.4 Design Memorandum and Maintenance Manual	93
 8. AESTHETICS	 94
8.1 General	94
8.2 Principles	94
 REFERENCES	 97
 TABLES	 105
List of Tables	107
Tables	111
 FIGURES	 141
List of Figures	143
Figures	145

APPENDIX A	ESTIMATION OF WAVE HEIGHT IN SURF ZONE	167
APPENDIX B	NOT USED	183
APPENDIX C	WORKED EXAMPLES	185
APPENDIX D	REFERENCE EXTREME SEA LEVELS AT QUARRY BAY/NORTH POINT AND TAI PO KAU	210
GLOSSARY OF TERMS AND SYMBOLS		214

1. INTRODUCTION

1.1 Purpose and Scope

The purpose of the Port Works Design Manual (the Manual) is to offer guidance on the design of marine works and structures normally constructed by the Government of the Hong Kong Special Administrative Region. Such works and structures include public piers, ferry piers, dolphins, reclamation, seawalls, breakwaters, pumphouses, beaches and associated marine facilities. The Manual has been written with reference to the local conditions and experience. Therefore, it may also provide a source of useful data and design reference for other marine works and structures constructed by other organizations or parties in Hong Kong.

The Manual is issued in five separate parts. The titles of these parts are :

- Part 1 – General Design Considerations for Marine Works
- Part 2 – Guide to Design of Piers and Dolphins
- Part 3 – Guide to Design of Reclamation
- Part 4 – Guide to Design of Seawalls and Breakwaters
- Part 5 – Guide to Design of Beaches

The recommendations in the Manual are for guidance only and should not be taken as mandatory. Compliance with these recommendations does not confer immunity from relevant statutory and legal requirements. Because of the variable nature of the marine environment, the design of marine works and structures relies particularly on the use of sound engineering judgement and experience. Practitioners should be aware of the limitations of the assumptions employed in a particular theoretical or computational method. Since the marine environment is a field where active research and development are continuing, it is beyond the scope of the Manual to cover all analysis and design methods. Practitioners should be prepared to explore other methods to suit a particular problem and should also realize that many of the methods will continue to evolve as more data and research findings are available.

This part (Part 1) of the Manual is arranged on a topical basis. It gives guidance and recommendations on the general environmental, operational, geotechnical, loading, material, durability, maintenance and aesthetic considerations and criteria relevant to the design of those marine works and structures mentioned previously. Worked examples are provided in Appendix C to illustrate the application of recommended design methods. Readers should refer to other parts of the Manual on particular aspects as necessary.

1.2 Definitions, Symbols and References

The definitions of terms and meanings of symbols for the purpose of this part of the Manual are given in the Glossary of Terms and Glossary of Symbols at the end of this document.

The titles of publications referred to in this part of the Manual are listed in the reference section. Readers should consult these original publications for more detailed coverage of particular aspects. For Works Bureau Technical Circulars (WBTC) which are updated regularly, reference should be made to their latest issues.

2. ENVIRONMENTAL CONSIDERATIONS

2.1 General

This chapter gives guidance on the investigation and assessment of the environmental data on sea levels, winds, waves and currents relevant to the design of marine works and structures. Records of these data available for Hong Kong conditions are also given.

The five-day normals of the meteorological elements for Hong Kong from 1981 to 2010 are given in Table 1. These have been taken from Surface Observations in Hong Kong by the Hong Kong Observatory.

2.2 Tide, Water Levels and Storm Surge

2.2.1 Datum

All levels for marine works should refer to the Hong Kong Principal Datum (PD). The PD is the vertical or height datum used for land surveying in Hong Kong and is referenced to the network of bench marks established by the Survey and Mapping Office. It is approximately 1.23 m below the mean sea level derived from 19 years (1965-1983) of tidal observations taken at the automatic tide gauge at North Point.

Another datum commonly used in navigation is the Chart Datum (CD). Formerly known as the Admiralty Datum, the CD is the datum on which all heights below mean higher high water mark on Admiralty Charts are based, and is very close to the Lowest Astronomical Tide in the Hong Kong harbour. The CD is 0.146 m below the PD and can be converted to the PD by this relationship.

2.2.2 Tidal Characteristics in Hong Kong

Tides are generated by the gravitational attractions between the Earth, Moon and Sun. Tides in Hong Kong are mixed and mainly semi-diurnal; on most days in a month, there are two high tides and two low tides. Large tidal range occurs twice a month during spring tides when the moon is new or full. On days around neap tides when the moon is at its first or last quarter, however, tidal ranges become small and sometimes diurnal tides with only one high tide and one low tide are observed. In general, the two high tides and the two low tides which occur each day are unequal in height. These tidal characteristics are summarized in Figure 1.

Tides at various locations in Hong Kong display a gradual change in tidal range and in the time of occurrence of high and low tides from the southeast to the northwest across the territory. In a tidal cycle, Waglan Island is typically the first to experience the high tide and low tide while Tsim Bei Tsui is generally the last. The mean delay is about 1 hour and 30 minutes for high tides and around 2 hours 30 minutes for low tides. The tidal range is largest at Tsim Bei Tsui and smallest at Waglan Island. The mean tidal range is 1.4 m at Tsim Bei Tsui and about 1 m at Waglan Island and the Victoria Harbour.

The locations of tide stations under the control of the Hong Kong Observatory are shown in Figure 2. These tide stations provide long term measured water level data over years. General water level information at the tide stations can be found in the Tide Tables published each year by the Hong Kong Observatory. In the tide tables, only the times and heights of high and low tides which occur each day are shown. For more detailed predictions on hourly tide levels at these stations, the Hong Kong Observatory should be consulted.

It should be noted that the water level information given in the Tide Tables of the Hong Kong Observatory are based on normal meteorological conditions. The observed water levels may differ from those given in the Tide Tables due to storm surges during tropical cyclones. The water level information given in Tables 2 to 9 described in Sections 2.2.3 and 2.2.4 is derived from observed water levels and has account for the effect of storm surges.

2.2.3 Mean Water Levels

The mean sea level, mean higher high water level, mean lower low water level at the eight tidal stations together with the period of data are shown in Table 2. The mean higher high water level is the average of the measured higher high levels and the mean lower low water level is the average of the measured lower low levels. The meaning of the higher high water level and lower low water level are shown in Figure 1.

2.2.4 Extreme Water Levels

Updated extreme sea level frequency analysis has been carried out for Chi Ma Wan, Ko Lau Wan, Quarry Bay/North Point, Tai O, Tai Po Kau, Tsim Bei Tsui and Waglan Island. Extreme sea levels for return periods of 2, 5, 10, 20, 50, 100 and 200 years for these seven tide station locations are given in Tables 3 to 9A. The period of records used in each case is given in these tables. At Quarry Bay/North Point and Tai Po Kau, the assessment was carried out on the basis of historic tidal measurement data. At other locations, data imputation with correlation to

Quarry Bay/North Point data was made to fill the missing data before the assessment. Generalised Extreme Values (GEV) distribution is generally used to estimate the return values of extreme sea level. The extreme sea levels given in these tables are statistical results of the tides or estimated tides happening since 1954 or 1962, where appropriate. They do not necessarily represent the highest possible sea water levels that may happen at respective locations. The designers shall be responsible for making due allowance in their design for sea level rise having regard to the following factors:

- (1) Sensitivity to sea level changes;
- (2) Local topography;
- (3) Possibility of being hit by tropical cyclones, in particular super typhoons, and the effect of concurrent occurrence of astronomical high tides; and
- (4) Climate change effect.

Frequency analysis was also carried out on data reconstructed from numerical simulations or observed by tide poles or tide gauges before 1954, which are non-instrumental in nature, for Quarry Bay/North Point and Tai Po Kau. Higher extreme sea levels are provided in Appendix D for reference. For design of important facilities which are vulnerable and sensitive to sea water level, e.g. E&M installations, designers may consider to take into account the historical storm surge records before 1954 as far as practicable.

Minimum sea levels observed at the 8 tide stations in Figure 2 are shown in Table 10.

2.2.5 Rise in Mean Sea Levels due to Climate Change

Recent climate research predicts that global mean sea level will continue to rise at current or accelerated rates. Mean sea level in Hong Kong is expected to rise as given in Table 42.

To obtain estimates of future extreme water levels for use in design, the sea level rise projections should be added to the extreme water levels given in Tables 3 to 9A.

The implications of rising sea levels should be considered for design of all marine works in Hong Kong. Water levels at the end of the design life should be considered.

2.2.6 Storm Surge Increase due to Climate Change

Recent climate research predicts that the intensity of tropical cyclones and associated storm surge and wind waves will increase as a result of climate change. Owing to the nature of differences in topography and bathymetry, the increases in extreme storm surge are anticipated to vary by location. The induced storm surge increase in Hong Kong at tide stations under

intermediate greenhouse gas emissions scenario [SSP2-4.5] is given in Table 44.

For design of coastal structures with the most extreme loading condition of having extreme wave condition at the higher return period, to obtain estimates of future extreme water levels for use in design, the storm surge increase at the same return period of the wave should be added to the extreme water levels given in Tables 3 to 9A and sea level rise projections under intermediate greenhouse gas emissions scenario [SSP2-4.5] given in Table 42.

2.3 Bathymetry

General information on the bathymetry of Hong Kong waters can be found in the nautical charts for the following areas published by the Hong Kong Hydrographic Office :

- Victoria Harbour – eastern part
- Victoria Harbour – central part
- Victoria Harbour – western part
- Lamma Channels
- Ma Wan and adjacent approaches
- Urmston Road
- Approaches in south eastern part of Hong Kong waters

These nautical charts provide the water depths below the Chart Datum. If other water level data are used to calculate the water depth, care should be taken to ensure that both the bathymetry and water level data refer to a common datum.

It should be noted that, apart from the information given in the nautical charts, detailed bathymetry surveys are normally required to determine the latest seabed levels and to supplement information at and around the site area of a project.

2.4 Wind

2.4.1 Wind Stations in and around Hong Kong

A number of meteorological stations are operated by the Hong Kong Observatory that measures wind data in different areas of Hong Kong. Four stations in Huangmao Zhou, Tuoning Liedao, Neilingding and Wailingding have also been installed in cooperation with the

Guangdong Meteorological Bureau. Figure 3 shows the locations of these stations. Details of the wind data collected at these stations should be checked with the Hong Kong Observatory.

2.4.2 Extreme Wind Speeds

Mean hourly wind speeds for return periods of 5, 10, 20, 50, 100 and 200 years for four of the main stations, namely, Kai Tak Southeast Station, Cheung Chau Station, Waglan Island Station and Hong Kong International Airport Station are given in Tables 12 to 14A. Mean wind speeds for durations of 2, 3, 4, 6 and 10 hours and return periods of 5, 10, 20, 50, 100 and 200 years for Kai Tak Southeast Station, Cheung Chau Station and Waglan Island Station and Hong Kong International Airport Station are also given in Tables 15 to 30F. The assessment was carried out by using GEV or Gumbel distribution, whichever gives greater values, to the annual maximum mean wind speeds for each duration and direction. The period of records used for each station is also given in the tables. The following points about these stations should be noted when applying their mean wind speed data:

- Both the Cheung Chau and Waglan Island Stations are better exposed geographically and not directly affected by urbanization. Their wind data are generally more representative of the wind conditions over Hong Kong.
- The wind data at Kai Tak Southeast Station are subject to the shelter effect of the mountains surrounding the harbour and urban development in the harbor area. Wind data at this station should not be used for locations outside the inner Victoria Harbour area.
- The wind data at Hong Kong International Airport Station are subject to the shelter effect of the mountains on the Lantau Island to the south. Wind data at this station are generally more representative of the wind conditions at the Western Waters of Hong Kong.

The mean wind speeds given in Tables 12 to 30F have been corrected to 60-min average wind speed while a brief history of the heights and locations of the anemometers at the four wind stations is given in Table 30G.

Extreme wind speeds for other wind stations are not shown because of the relatively short period of data collection.

For conversion of the mean hourly wind speeds to mean speeds with durations of less than one hour, the following conversion factors may be cited :

<i>Duration</i>	<i>Conversion Factor</i>
1 minute	1.19
5 minutes	1.11
10 minutes	1.09
20 minutes	1.05
1 hour	1.00

Caution should be taken when using the above values, as the conversion factors are greatly affected by the surface roughness and topography around a site of interest.

2.4.3 Directional Distribution of Wind

Pictorial summaries of the frequency distribution of wind direction and speed measurements at Kai Tak Airport Southeast Station, Cheung Chau Station and Waglan Island Station are given for an annual basis in the form of wind roses in Figure 4.

2.4.4 Increase in Extreme Wind Speeds due to Climate Change

Tropical cyclone intensity is expected to increase as a result of climate change. Extreme wind speeds for 2050 and 2090 are expected to increase as given in the projections under intermediate greenhouse gas emissions scenario [SSP2-4.5] Table 43.

To obtain estimates of future extreme wind speeds for use in design, the increased wind speed projections should be added to the extreme wind speeds given in Tables 12 to 30F.

The implications of increasing wind speeds on wave generation (height and period) should be considered for design of all marine works in Hong Kong. Changing wave parameters throughout the design life of a structure should be considered to ensure the worst loading cases are identified.

2.5 Waves Generated by Winds

2.5.1 General

Estimates of extreme wave conditions at a site should ideally be obtained by extrapolating a series of wave measurements made at or close to the site. However, because of the relatively high cost of setting up a wave recording system, and the need for records covering a suitably long period (more than several years) to enable sufficiently reliable extrapolation, direct wave record may not be available for the design of marine works or structures.

In Hong Kong waters, the most severe wave conditions are usually associated with storm waves and, in the absence of wave records, wave forecasting from wind records can be used to predict such conditions, as outlined in later sections. In some situations, particularly where there is direct exposure to the South China Sea and longer period waves are therefore considered important, swell waves from distant storms should be taken into account during design.

Because of the complex geographical features in Hong Kong waters, waves propagating into such waters are likely to be transformed by processes such as refraction, diffraction, reflection, breaking and seabed friction. These processes may have significant influence on the wave climate in the area to be studied. The designer has to assess these factors at an early stage to ascertain whether more sophisticated analysis has to be carried out. Computer models are available for such analysis and are recommended for use in studying the wave transformation in complex areas. These models have to be calibrated to make sure that they are suitable for that particular study area.

2.5.2 Wave Characteristics

Characteristics of waves that should normally be considered in design are given in the following paragraphs.

(1) Wind Waves and Swells

Waves can be broadly classified as wind waves and swells. Wind waves, also known as seas, are those under the influence of wind in a generating area. In general, wind waves are highly irregular in appearance and tend to be short-crested. Swells, on the other hand, are wind-generated waves that have travelled out of the region of their generating area. Outside the generating area, no energy is supplied from the wind, and therefore swells gradually decay due to various energy dissipating and transformation processes, but their periods are elongated

during propagation. Swells have regular, long crest appearance, and are less steep than wind waves. A sea state may consist of just wind waves or just swells or may be a combination of both.

Waves can also be broadly classified as deep water and shallow water waves according to the water depth to wavelength ratio as follows :

- Deep water waves Water depth/wavelength ratio greater than 0.5
- Intermediate-depth water waves Water depth/wavelength ratio between 0.04 and 0.5
- Shallow water waves Water depth/wavelength ratio less than 0.04

(2) Wave Propagation

For deep water waves, the most important processes in the development of the wave field are usually energy growth from the wind, deep water wave propagation and eventual decay of wave energy. The seabed generally does not have an influence on the wave field in deep water. When waves encounter an island, headland or obstacles during their propagation, they diffract through these obstructions and such phenomenon should be account for in wave analysis.

Waves entering into water areas with water depth generally less than about one-half of the wavelength, however, are subject to the influence of the seabed. These waves undergo refraction by which the wave height and direction of propagation vary according to the topography. The wave height also changes as a result of the change in the rate of energy flux due to the reduction in water depth, even if no refraction takes place. This is the phenomenon of wave shoaling. Wave attenuation will occur due to bottom friction and should not be neglected in an area of relatively shallow water that extends over a great distance with very gentle inclination in the sea bottom. For wave conditions inside tidal basins or typhoon shelters, the effect of diffraction through the entrance and reflection inside the boundary of the basins or typhoon shelters should also be considered.

As waves approach the shore in shallow water, the wavelength decreases and the wave height may increase, causing the wave steepness (wave height/wavelength) to increase until a limiting steepness is reached. At this limiting steepness, the waves break. In the water shallower than 2 to 3 times the offshore wave height, waves begin to break and wave heights decrease gradually. The region where many waves break is called the surf zone. Breaking waves exert greater loading effects on the structures and it is therefore necessary to check in design if the structures will be subject to breaking waves.

(3) Types of Wave Propagation

Three classic cases of wave propagation describe most situations found in coastal engineering :

- Case 1 : Sea state with wind waves and swells – A storm generates deepwater waves that propagate across shallower water while the waves continue to grow due to wind.
- Case 2 : Sea state with wind waves only – Wind blows over the water areas around the site of interest and generates waves that propagate to the site. In this case, there is no propagation of waves as swells from a remote area.
- Case 3 : Sea state with swells only – A storm generates winds in an area remote from the site of interest and as waves cross shallower water with negligible wind, they propagate to the site as swells.

All cases may happen at a site, but the first and the second cases are relatively complex and require mathematical model for reasonable treatment in particular when variable shoreline and seabed topography are present. The use of mathematical model for wave estimation is given in Section 2.5.8.

The third case may be handled by approximating the swell as a monochromatic wave, and manual refraction and shoaling calculation methods may be used to estimate the nearshore wave climate. In variable seabed bathymetry, however, these manual procedures have the drawbacks of ray crossing and bathymetry inadequacy on ray paths that will result in inaccurate wave estimate, and the use of mathematical model is still recommended.

2.5.3 Wave Parameters

There are two approaches to describe the waves in the natural sea state, namely, the wave train method and the spectral method.

(1) Wave Train Method

The wave train analysis determines the wave properties by finding the average statistical quantities of individual wave components present in a wave record. Two of the most

important parameters necessary for adequately quantifying a given sea state are the wave height and the wave period.

The most commonly used characteristic wave height parameter to represent the wave condition of a sea state is the significant wave height. The significant wave height has been found to be very similar to the estimated visual wave height by an experienced observer. The definitions of typical wave parameters are given as follows :

- Significant wave height – The average of the highest one-third of the wave heights in a wave record is called the significant wave height ($H_{1/3}$ or H_s). From one wave record at a point with N measured wave heights, the significant wave height can be estimated by ordering waves from the largest to the smallest and assigning to them a number from 1 to N . The average of the first highest $N/3$ waves is the significant wave height.
- Significant wave period – It is the average of the periods of the highest one-third of the wave heights in the wave record ($T_{1/3}$ or T_s).
- Mean wave period – It is the average of all the wave periods in the wave record. The mean wave period obtained by averaging the periods of all the waves with troughs below and crests above the mean water level is also called the zero-crossing period T_z .

Wave height measurements in deep water have been found to closely obey a Rayleigh distribution. For Rayleigh distributed wave heights, the maximum wave height H_{\max} in a wave record can range from $1.6H_{1/3}$ to $2H_{1/3}$: a larger H_{\max} tends to appear as the number of waves in a record increases. The relationship of other higher wave heights with $H_{1/3}$ is shown in Table 31. The Rayleigh distribution is generally adequate except for shallow water where no universally accepted distribution for waves exists. Within the surf zone, larger waves are gradually eliminated by the depth-limited breaking process and the wave height distribution becomes narrower than the Rayleigh distribution. Thus, in the surf zone region, the Rayleigh distribution should not be applied and the method described in Section 2.5.9 may be used to estimate the relationship between $H_{1/3}$ and H_{\max} .

The wave period does not exhibit a universal distribution law but the relationship of the significant wave period and the zero crossing wave period may be approximately related in a general way as follows :

$$T_{1/3} \sim 1.2T_z$$

The periods of other larger wave heights (see Table 31) may be taken as equal to the significant wave period.

(2) Spectral Method

Unlike the wave train method, the spectral analysis method determines the distribution of wave energy with respect to the frequency and direction by converting time series of the wave record into a form of energy spectral density function, which is called the directional wave spectrum. The directional spectrum is expressed as the product of the frequency spectrum and the directional spreading function. The wave frequency spectrum may be obtained from a continuous time series of the sea surface elevation with the aid of the Fourier analysis by considering the waves as a linear superposition of a large number of simple, small-amplitude wavelets with different frequencies travelling independently of one another. The representation of the waves in the form of wave spectrum is shown in Figure 5. The directional spreading function expresses the degree of wave energy spreading in the azimuth from the principal direction of wave propagation. Wind waves shows a large directional spreading, while swells have a narrow spreading.

The wave spectrum gives an estimate of the spectral significant wave height H_{m0} by the following relationship :

$$H_{m0} = 4\sqrt{m_0}$$

where m_0 is zero-th moment or the total area of the wave spectrum.

The period parameter that can be obtained from a wave spectrum is the peak period, defined as the period associated with the largest wave energy (see Figure 5). An approximation of the zero crossing wave period may be obtained from the wave spectrum by the following relationship :

$$T_z \approx \sqrt{\frac{m_0}{m_2}}$$

where m_2 is the second moment of the wave spectrum in frequency time domain as indicated in Figure 5.

and T_z is the zero crossing period.

The zero-crossing period from the spectral method is only an approximation and the peak period can only be obtained through the spectral analysis. For wind waves in deep water, the peak period T_p may be approximated by $T_p = 1.1T_{1/3}$ in the absence of realistic information.

The frequency spectra for storm waves may sometimes be multi-peaked. One peak may correspond to swells occurring at lower frequencies (longer periods) and one or sometimes more peaks are associated with local wind waves at comparatively higher frequencies (shorter periods). The direction of swells may also differ from those of wind waves. In a multi-peaked spectrum, the effect of different peak periods and the zero crossing period calculated from such a spectrum should be investigated in the design.

(3) Relationships of $H_{1/3}$ and H_{m0}

The principles of modern wave forecast mathematical models and wave recorders are generally based on the spectral method providing outputs on the above spectral wave parameters. However, the significant wave height $H_{1/3}$ is commonly used to characterize the wave condition and therefore, it is necessary to understand the relationships between the wave parameters derived from the wave train and spectral methods.

While $H_{1/3}$ determined from the wave train method is a direct measure of the significant wave height, H_{m0} from the spectral method provides an estimate of the significant wave height. A number of field measurements over the world have yielded the average relationship of $H_{1/3} = 0.95 H_{m0}$ in deep water. As waves propagate into shallow water, waves exhibit nonlinear characteristics and $H_{1/3}$ becomes equal to or even slightly greater than H_{m0} . When waves further travel into very shallow water and begin to break, however, the spectral analysis loses its effectiveness because waves cannot be considered as a linear superposition of small-amplitude wavelets. Thus, the estimation of $H_{1/3}$ based on H_{m0} should be made in deep to relatively shallow water only. When the wave information within the surf zone is required, it is recommended to begin with the spectral data in the offshore and to evaluate the wave transformation by breaking as given in Section 2.5.9.

2.5.4 Wave Conditions in Hong Kong

Under normal weather conditions, waves are usually mild in most parts of Hong Kong waters. When strong monsoon wind prevails, higher waves can be experienced at the more exposed locations and may last for a few days or even longer in the presence of the monsoon wind. According to the Hong Kong Observatory, northeasterly monsoon occurs from September to May while southwesterly monsoon blows from June to August, and the northeasterly monsoon

is usually stronger than the southwesterly monsoon. Hence, waves due to northeasterly monsoon are generally higher than those generated by the southwesterly monsoon.

Extreme wave conditions in Hong Kong are due to tropical cyclones. Cyclone is an area of low atmospheric pressure surrounded by a circular wind system attaining maximum wind speed near its center. Winds due to tropical cyclones are characterized by their high speed and rapidly changing direction and the wind field normally covers a large region. The wave climate in Hong Kong waters changes when a tropical cyclone encroaches upon Hong Kong, as described below :

- When the cyclone is far away, its wind system has little or minor effect on the wave climate in Hong Kong. Local wind waves are generally insignificant. There could be a noticeable increase in the offshore swells from the southerly and southeasterly directions travelling a long distance from the cyclone.
- As the cyclone moves closer to Hong Kong, swells in Hong Kong waters become stronger and the local wind speeds also increase at the same time. Depending on the location of the cyclone and its distance from Hong Kong, the swells and the local wind waves are not necessarily approaching from the same direction.
- When the cyclone passes over or in the close vicinity of Hong Kong, very strong winds can prevail, resulting in high local wind waves. At the same time, offshore swells continue to contribute to the local wave climate for areas exposed to the southerly or southeasterly direction.

Under normal weather condition, the use of a constant uniform wind field is considered appropriate for wave prediction. In extreme condition during tropical cyclones, wave prediction using mathematical wave models capable of handling time varying non-uniform wind field is regarded as the most realistic wave prediction method in principle. However, this involves significant calibration effort and difficulty in getting comprehensive wind data over large area coverage throughout the period of typhoon development and propagation. The use of constant uniform wind fields using the extreme wind speed data corresponding to various incoming wave directions given in Tables 12 to 30 may be considered acceptable as a pragmatic alternative in wave prediction for engineering design.

2.5.5 Wave Data and Data Sources

(1) Measurement Data

Wave information can be obtained directly from field measurement. For general information on wave recording and analysis, reference may be made to Section 26 of BS6349:Part 1 (BSI, 2000).

Two bed-mounted wave recorders have been installed near Kau Yi Chau and West Lamma Channel as shown in Figure 6 since 1994 as part of Civil Engineering Department's long term wave monitoring programme in Hong Kong waters. The following parameters are provided from the outputs of the recorders :

- Spectral significant wave height H_{m0} .
- Maximum recorded wave height H_{max} .
- Peak wave period T_p .
- Zero crossing wave period T_z .
- Mean wave direction.
- Average water depth.

The average recorded water depths at Kau Yi Chau and West Lamma Channel wave stations are respectively about 9 m and 10 m.

A summary of the wave measurement between 1994 and 2020 is given in Tables 32 and 33. The wave measurement over these periods reflect that the prevailing wave directions in the measurement locations are the south and southeast, and extreme wave heights are generally aligned with the presence of tropical cyclone events. It should be noted that the recorded spectral significant wave height H_{m0} at these two wave stations may be taken to be approximately the same as the significant wave height $H_{1/3}$ for design purpose. More details of these data, such as the full set of wave output files, can be obtained from Civil Engineering Department if required.

(2) Wave Data from Storm Hindcasting

Storm hindcasting is based on the estimation of the wave height at a particular location associated with past storm events. If there is a sufficiently long period of storm records, it is possible to estimate the extreme wave heights based on the hindcast wave heights of each storm events by means of extreme value analysis.

A hindcasting study had been undertaken to estimate the significant wave heights at two

offshore locations as shown in Figure 8 by means of a mathematical typhoon model with reference to 47 typhoons occurred in Hong Kong between 1948 to 1994 (HKPU, 1995 & 2000). For each year, the typhoon that most probably generates the annual maximum wave height in Hong Kong was chosen and its characteristics, including tracks and pressure distribution, were input to the model to estimate the significant wave height. Based on the significant wave height computed each year, an extreme value analysis based on Weibull distribution was performed to determine the significant wave heights of different return periods. The results are shown in Table 34. The estimated significant wave height for given return periods may be considered for design purposes as the offshore wave condition from which the nearshore wave conditions in Hong Kong can be calculated after due consideration of various wave transformations, but the users are advised to seek for the latest information on storm wave prediction results.

It should be noted that no specific direction and period information are given in Table 34 due to data limitation in the hindcasting study. When using the wave information, it may be assumed that the waves are travelling from directions approaching towards Hong Kong waters and the critical direction relevant to the site of interest should then be adopted in wave analysis. For storm waves, the wave steepness, $2\pi H_{1/3}/(gT_{1/3}^2)$, is generally in the range of 0.03 to 0.06. The range of period of the waves given in the table may be estimated by equating the wave steepness to equal 0.03 to 0.06. The wave period most critical for the safety of structure under design should be selected within the above range.

(3) Ship Observation Data

Visual observations of wave conditions are reported from ships in normal service all over the world, and sometimes these data are used to estimate the wave conditions when wave information is absent. In offshore area where the wave climate does not vary quickly with position, observations from a wide area based on a large number of observations can be gathered together and give a general indication of the wave climate of the area.

Records of ship observed wave data within the area of the South China Sea bounded by longitudes 100°E and 120°E and by latitudes 0°N and 30°N are kept by the Hong Kong Observatory. The areas covered by these ship observations may include some relatively protected inshore region. If information on waves is required from ship observations for a particular project, an open area should therefore be considered when approaching the Hong Kong Observatory for details of records held. Ship observation wave data of the South China Sea can also be obtained from the Global Wave Statistics (Hogben et al, 1986). The statistics provides compiled information on the frequency of joint occurrence of wave heights and

periods for different directions in various ocean areas of the world.

It should be noted that these data are very scattered in time and space, and ship navigation will generally avoid passage through storm locations. Visual observations from ships by their nature are unable to produce a complete and reliable description of waves. Caution should be exercised if these data are used.

2.5.6 Wind Data for Wave Prediction

A common approach to predict the wave conditions is to use wind data in wave prediction if wave data are not available. Actual wind records from the site of interest are preferred so that local effects are included. If wind measurements at the site are not available and cannot be collected, measurements at a nearby location will be useful.

Attention should be paid to the following aspects before applying the measured wind speeds in wave prediction :

- Wind speed at the level of 10 m above mean sea level should generally be used in wave prediction formulae or mathematical wave model. The wind speeds given in Tables 12 to 30F can be directly for this purpose based on the following considerations:
 - (a) No correction was needed for the wind data at Kai Tak Southeast Station and Hong Kong International Airport Station as the recording heights are close to the standard height of 10 m.
 - (b) It should be noted that the normal wind-height adjustment formulae, including the one-seventh power law and the Hellman formula, are not recommended for use in Hong Kong conditions. Hence, it is considered more conservative to use wind data at Waglan Island and Cheung Chau wind stations which have recording heights of 83 m and 98 m above mean sea level respectively.
- The wind speed should be adjusted from the duration of the observation to an averaging time appropriate for wave prediction. In general, several different averaging times should be considered for wave prediction to ensure that the critical wave condition can be identified. Conversion factors for duration of wind speeds less than one hour are given in Section 2.4.2. However, the

applicability of these conversion factors to a site of interest should be checked by the users of this Manual because the conversion factors listed there are not universally applicable. For duration greater than one hour, the respective wind speed information is given in Tables 15 to 30F.

- If the wind data are collected inland, the measured wind speeds may not be able to represent the wind speeds over water. No simple method can accurately represent the complex relationship of inland and over-water wind speeds. However, if a wind measurement station on land is adjacent to the water body, the measured wind speeds may be considered equivalent to those over water. This applies to the wind speeds given in this Manual as the wind stations are located adjacent to the sea.
- An adjustment for the effect of the stability of the boundary layer of the atmosphere on the wind speeds due to air-sea temperature difference should be made by means of a stability correction factor for fetch length exceeding a certain distance. In the absence of local information, a stability correction factor of 1.1 may be assumed for fetch length greater than 16 km for the purpose of wave assessment.

2.5.7 Wave Prediction from Wave Measurement

Estimates of extreme wave conditions by extrapolation of measured wave data are only reliable if the original data are derived from a large number of years. The method of prediction consists of plotting the initial wave heights against the cumulative probabilities of occurrence, using an appropriate probability function. The objective is to achieve a graph which may then be extended to give an estimate of the extreme conditions. An example of such method can be found in Section 27 of BS 6349:Part 1 (BSI, 2000).

2.5.8 Wave Prediction by Mathematical Modelling

The use of mathematical models to estimate the wave conditions is recommended for water areas with variable bottom topography and shoreline configuration and subject to the effect of swells and wind waves. Details of the input requirements vary among various types of models developed by different organizations and therefore reference should be made to the user's manuals of these models accordingly when the models are used. Expert advice or input should be sought where appropriate as specialist software and experience are usually required in wave modelling.

Where mathematical wave modelling is applied, a modelling report should be prepared to describe the wave spectrum employed and the modelling approach, procedures and results, and should include the following information :

(1) Wave Spectrum

Wave transformation analysis should be made for irregular waves except for special cases such as long-travelled swells approaching a coast with nearly parallel, straight depth contours for which monochromatic wave analysis may yield reliable results. Because transformations of irregular waves depend on the functional shapes of directional wave spectrum, the frequency spectrum and directional spreading function employed should be stated so that a check of the analysis can be made afterward.

(2) Types of Wave Models

The type of models and their principles, assumptions and limitations should be specified because each type of model has its range of applications reflecting its theoretical basis. For example, wave propagation models may not be able to give detailed description of the wave climate in a tidal basin, harbour or typhoon shelter due to diffraction and reflection and therefore separate diffraction and reflection models may be used in combination with the wave propagation models under such condition. Explanations should be given on why the chosen models are suitable for the project and the required accuracy of the wave results.

(3) Site Analysis

A general description of the physical characteristics of the site should be given as they would be important in the selection of the model boundary, applicability of the type of wave models to be used and understanding the problems that may arise in the analysis. This should include the layout of shorelines, seabed irregularity, water depth and the exposures of the site to different incoming wind or wave directions. Special features such as presence of shoals, seabed depressions, navigation channels, islands, headlands and structures should be highlighted.

(4) Model Set-up

The report should provide the input information in the wave models, which should include the following :

- Layout of shoreline, islands and structures.
- Bathymetry.
- Water level.
- Wind speed, duration and direction.
- Wave height, period and direction.
- Model boundary and boundary conditions.
- Computational grid and time steps.
- Other modelling parameters such as bottom friction, wave breaking index or direction spread of waves, depending on the type of models adopted.

An explanation of why the chosen model boundary and boundary conditions are appropriate for the project should also be given. As an indication, the location of the model boundaries should be set as far away from the areas of interest as possible, but without covering too large an area that will affect the computational efficiency. Locations where there are sheltering of waves or oddness of bathymetry that would make the input site inappropriate as model boundary should be avoided.

(5) Calibration

The purpose of the calibration is to ensure that the computed results can realistically represent the wave climate and is achieved by tuning the wave model to reproduce the known or measured wave conditions for a particular situation. In this connection, evidence of calibration for a particular chosen model, such as comparison of modelled results with measured data, sensitivity tests on variation of input parameters and accuracy achieved, should be presented in the report.

(6) Computation Results

The results should be plotted and examined for any signs of computational instability or unreasonable variations in wave height or direction over short distances. Checking should also be made if the values of the computed wave conditions are consistent and reasonable with respect to the shoreline or bathymetry configuration in the area being examined. A summary of the computed wave conditions at the site of interest for various chosen design scenarios should be given at the end of the report.

2.5.9 Wave Breaking in Surf Zone

The often quoted figure of the maximum wave height being equal to 0.78 times the still water depth can be derived from the theory describing individual waves. However, sufficient difference exists in models between results with random waves and results with individual waves to indicate that the above figure is not an adequate estimate of the breaker height in all situations. A method by Goda in Appendix A may be used to estimate the wave heights in the surf zone.

A design chart that relates the shoaling coefficient with the equivalent deepwater wave steepness, the slope of seabed and the relative water depth is shown in Figure A1 of Appendix A. The dotted lines in the figure for the seabed slope demarcate the regions of wave breaking and non-breaking. When the intersecting point of the relative water depth and equivalent deepwater wave steepness falls in the region above the dotted lines, wave breaking will occur. This procedure may be used to check whether the structure lies in the breaking wave region or not.

The wave heights in the breaking wave region or the surf zone do not follow a Rayleigh distribution as larger wave heights break under the limited water depth. If a structure is found to be inside a surf zone, the Goda formulae or the corresponding design charts in Figure A2 in Appendix A may be used to estimate the significant wave height and the maximum wave height in the surf zone. In the event that the wave condition is found to be marginal between non-breaking and breaking, it is suggested that both the non-breaking and breaking wave conditions be checked in the design to determine which condition is more critical to the structure.

2.5.10 Use of Physical Wave Modelling

Physical wave models can be used as a predictive scale model for the prototype or as a verification model for a mathematical one. As the present state of the art of mathematical wave modelling is often sufficient for general design purposes, physical modelling is mainly applied when a complicated bathymetry in front of a structure causes significant variations in the near-structure sea state or when detailed structural design aspects related to run-up, overtopping, toe scour or rock movements have to be clarified. It is mainly due to this capacity to deal with complex interactions that leads to physical models being selected to obtain the necessary design data. For many of the typical design problems, however, mathematical model may be the more economical and efficient option. Therefore, expected accuracy must be balanced against the cost of both mathematical and physical modelling.

2.5.11 Wave Overtopping

Information of the amount of wave overtopping is needed to determine the crest level of marine structures. The methods for assessing the amount of wave overtopping are given in Part 4 of the Manual – Guide to Design of Seawalls and Breakwaters.

2.6 Ship Waves in Harbour

The wave climate in the Victoria Harbour is dominated by ship waves due to the movement of marine traffic. According to an inner harbour wave study (HKU, 1997), it was concluded that the wave climate in the Victoria Harbour, based on field measurements, has the following characteristics :

- The wave climate is dominated by the ship waves which are highly irregular in nature.
- The period of the ship waves so generated tends to be short and is in the range of about 2 to 5 seconds.
- Waves in the western portion of the harbour area are stronger than those in the eastern portion.
- Waves in the region off the northwest shore of Hong Kong Island are generally the strongest in the harbour area.
- Waves in busy navigation area are stronger than those in open areas with less marine activities.
- Waves during daytime are stronger than those at night.

The distribution of wave regions and the observed significant wave height corresponding to each wave region are shown in Figure 9 and Table 35. A typical daily wave height variation is also shown in 10. According to the inner harbour wave study, about 80% of the wave energy within the Victoria Harbour in the daytime is due to marine traffic and the balance is due to other sources such as winds. A description of the effect of waves on harbour activities in various wave regions is summarized in Table 35.

Where new reclamation and marine structures are constructed in the Victoria Harbour, check should be made, for example, by mathematical wave modelling, to see if the works will lead to deterioration of the existing wave climate.

2.7 Currents

2.7.1 General

Currents are the movement of water in the sea and can be generated by the effect of tide, wind, waves, river discharge and density difference and are described by their velocities (speed and direction). Information on currents in specific locations may be obtained from reports prepared by consultants for various Government departments in the past. The Civil Engineering Department, Environmental Protection Department, Territory Development Department and Marine Department should be consulted in the first instance for details of studies carried out in any areas for which information on currents is required.

2.7.2 Field Measurements

For locations where no information on existing currents is available, it may be necessary to carry out measurements on site. Field measurements give realistic local and time-specific information on flow conditions and can provide surveyed data for the calibration of mathematical flow models. However, the quality of the field data may be affected by the variability of the forcing conditions such as river flow, tide, wind and waves acting along and over the water area. Hence, the planning of the field measurement work and the period of measurement should consider the meteorological and tidal characteristics of the area of interest, and aspects of the study for which the current data are needed, taking into account the following points :

- Two meteorological seasons prevail in the region of the Pearl River Estuary : the dry season lasts approximately from October to April in which the northeast monsoon in the South China Sea dominates and the wet season lasts from approximately June to August in which the southwest monsoon prevails. These two major seasons are separated by a transitional period which generally extends over the month of May and September. Depending on the amount of rainfall received within the drainage basin of the Pearl River, the amount of freshwater discharged into the estuary varies significantly in these two seasons. As a result, the current velocities measured in these two seasons will also vary significantly.
- Variation of tide in the region is characterized by the spring and neap tides according to the relative positions of astronomical bodies. Since tidal flow is one of the essential forcing conditions to the estuarine behaviour, each seasonal field measurement should be conducted to cover a spring and neap tide.

- The minimum observation period should be a complete tidal cycle, which is about 25 hours for two high tides and two low tides in the semi-diurnal tidal regime in Hong Kong.
- Stratification in some areas may be significant. Field measurement should be made in such a way as to provide full information on the velocity and salinity profile at the monitoring point.

The flow conditions can be determined on site by means of the Eulerian and Lagrangian methods. The Eulerian method is a measurement of water flowing through an instrument with fixed spatial coordinates such as a current meter or an acoustic doppler current profiler. The resultant current speed and direction at a specific point at different water depths can be obtained by this method. In the Lagrangian method, a number of floats or drogues are usually used and are released at pre-determined release point. The paths of movement of the drogues are then measured regularly until they are recovered. This method enables the tracing of the actual paths of the currents. Its limitation is that only the surface water movement is tracked and heavy marine traffic may make the method not feasible. A combination of these two methods can be employed in a current survey for mathematical modelling to provide measurements for calibration of a hydraulic flow model and to provide information on the path of the current for checking the level of confidence of the modelling results.

2.7.3 Current Prediction by Mathematical Models

Mathematical modelling is necessary to provide realistic estimation of the characteristics of the flow field in the coastal waters as the flow systems in these water areas are usually very complex due to irregular shoreline, variable bathymetry and a number of interacting tidal, wind, pressure and density gradient forcing conditions. Details of model application depend on the types of models to be employed, and expert advice and input are required as these models are normally not easy to apply. General principles on mathematical flow modelling are given in the following paragraphs.

(1) Model Category

In coastal or estuarine situations, two-dimensional or three-dimensional models should normally be used. Two-dimensional flow models for use in coastal or estuarine situations are generally depth-integrated. They provide a single velocity vector representing the flow condition over the whole water column in each horizontal cell of the modelled area. These

models are generally used in situations where the currents are approximately uniform throughout the water column or for studies in which the surface elevation are the primary concern. Three-dimensional models are used when the vertical structure of currents is not uniform. For Hong Kong waters which is subject to the effect of monsoon winds and the discharge from the Pearl River, the use of three-dimensional models is essential when the vertical distribution of currents is an important aspect of the study.

(2) Model Set-up

The setting up of a mathematical flow model involves the establishment of the shoreline, bathymetry, model boundary and boundary flow conditions, wind field, computational grid and values of other physical parameters such as river discharges and bottom friction of the seabed. Details of the input requirement should be consistent with the particular notation and format adopted by the models. In general, the following aspects should be noted :

- The shoreline in the model should take into account known and foreseeable reclamation or marine structures constructed along the shore.
- The model boundaries should be set as far away from the areas of interest as possible, but without covering too large an area that will affect the computational efficiency as inaccuracies and uncertainties in the boundary conditions will immediately affect the model performance. If the extent is too small, the phenomena in the modelled area will be dominated by the boundary conditions. The natural effects of the geometry, depth and friction on the flow will not be able to be reflected in the computation.
- The computational grid should be established in such a way to reflect the details of the shoreline configuration, bathymetry and to yield the required resolution of the current vectors in the area of interest. As a general rule, small grids should usually be used around the harbour, channels and sensitive receivers, and a relatively coarse grid may be acceptable in remote areas and the open sea.
- The seabed bathymetry should be accurately schematized in the model as the water depth is an important parameters that determine the global and local current distribution. An overall picture should be in mind from a preliminary study of bathymetric records before starting the schematization.

(4) Calibration

The application of a mathematical flow model should involve a calibration procedure in which the model is run to compare with the hydrodynamic flow field of a specific period in which field data have been collected. In calibration, model parameters such as seabed bottom friction or depth resolution are adjusted to optimize the comparison of computed data to field data. Comparisons are generally made to water levels and velocities, and may include reproduction of temperature and salinity. Discrepancies may be progressively minimized through a number of simulation runs based on sensitivity analysis of the boundary conditions, physical and numerical parameters. It is also necessary to check the performance of the calibrated model in an alternate time period with another set of field data, which are collected independently from the set used for calibration, by a verification process. The verification procedure may result in some fine-tuning of the model input parameters.

(5) Simulation Conditions

The flow conditions to be simulated should take into account the variability under different seasons and tidal periods. In general, the following situations should be considered in a mathematical flow modelling for Hong Kong waters :

- Flow during flood and ebb tides.
- Flow in spring and neap tides.
- Flow in wet and dry seasons.

(6) Modelling Report

A mathematical modelling report should be prepared to summarize the modelling approach, procedures and the computation results, and should include the following details :

- Type of flow model employed and the principle, assumptions, limitations and range of applicability.
- Model boundary and computational grid.
- Bathymetry of the modelled area.
- Input data, including boundary conditions, wind speed and direction, river discharge and other physical parameters.
- Calibration results and accuracy achieved.
- Computation results of various simulation scenarios.

2.7.4 Use of Physical Flow Modelling

Physical modelling is an option for complicated current patterns for which, despite their complexity, the boundary conditions can be reproduced well in the laboratory. Examples are structures exposed to combined current and wave action, complex bathymetry and unconventional structure geometry. Physical modelling may be useful in the following situations :

- Where interference of currents and waves is concerned, although mathematical models have been developed to cover this situation.
- Where verification of or comparison with a mathematical model is required.
- Where the physical model can be built and operated at a competitive cost in relation to other options.
- Where the influence of vortices generated from the edges of structures or the sharp corners of topography needs to be studied.

2.8 Sediments

In general, the sedimentation rate at estuaries and coastal regions is dependent on river discharge, land erosion, tidal current as well as the prevailing storm and wave climate. In Hong Kong waters, the natural long-term sedimentation rate is governed primarily by the amount of sediments originating from the river discharges and tidal currents. Since the transport and deposition processes of sediments are very complex, analytical prediction of the suspended sediment concentrations and the prevailing sedimentation rate at a given area of interest is difficult. Mathematical modelling is therefore used to simulate and assist in predicting the outcome of such complex processes.

Sediment models simulate the transport of sediments by advection, wind, settling, resuspension and random turbulent processes. In most cases, sediment models use a hydrodynamic database that is generated by a flow model similar to that mentioned in Section 2.7.3 as the basic input. To minimize computational effort without compromising on accuracy, the computational grid of a sediment model is normally an optimum aggregation of the flow computational grid. With the hydrodynamic database in the background, other physical and control parameters are used as input to simulate the physical processes involved. The results of a sediment model study are just as good as the calibration of these parameters. Hence, physical parameters such as settling velocity of the sediments and critical stresses for resuspension and sedimentation have to be calibrated before the models can be reliably used in any sedimentation studies.

To calibrate the above physical parameters, it is generally agreed that the following field data will be very useful in the calibration of a sediment model for sedimentation studies :

- Data on maintenance dredging in the vicinity of the area of interest.
- Amount of sediment discharged from river.
- Long-term data on suspended sediment concentration of the area.
- Short duration time series of suspended sediment concentration under a known hydrodynamic condition.

It should be noted that details of the model application and required input data depend on the types of sediment models to be employed and expert advice should be sought where necessary. A sedimentation modelling report, with details similar to those described in Section 2.7.3, should be prepared after completion of the modelling work.

2.9 Design Allowance with Progressive Adaptive Approach to Enhance Climate Resilience

While climate change has been established among the scientific community to be occurring and the trends are upward, there is significant uncertainty about the magnitude of future climate change impacts particularly towards the end of century and beyond due to uncertain future greenhouse gas emissions. Depending on climate actions taken by global countries to reduce greenhouse gas emissions, development of climate change effects may follow different possible pathways in long-term future.

Considering the uncertainties in the range of possible future climate change development and global actions among nations on reducing carbon emissions, the progressive adaptive approach shall be adopted to formulate climate adaptation measures for marine works. This approach is to be flexible and adaptive enough that they can be changed or updated as conditions change or if impacts due to climate change are different from that anticipated.

Under the progressive adaptive approach, with a view to further enhancing the resilience against climate change for new coastal structures, against possible higher greenhouse gas emissions scenarios, the design allowance in design of adaptation measures, including the possible projection differences between very high greenhouse gas emissions scenario [SSP5-8.5] and intermediate greenhouse gas emissions scenario [SSP2-4.5] in sea level rise ($\Delta_{\text{sea level rise}}$), storm surge increase ($\Delta_{\text{storm surge increase}}$) and wave effect ($\Delta_{\text{wave effect}}$) is required. With these design sea level and design wave height under higher greenhouse gas emissions scenario, the wave overtopping will become larger. The crest elevation of seawall cope level

must be raised to offset the increase in wave overtopping rates. The required raise of the crest elevation is the design allowance.

Design allowance given in Table 45 should be added to the design cope level of new coastal structures such as seawalls, breakwaters, piers and wave walls in Hong Kong, e.t.c. to enhance climate resilience.

With due consideration of other factors with care and supporting evidence, e.g. social impacts, operation requirements, technical/site constraints and feasibility of upgrading the structures, the designer can either adopt the design allowance in one-go or adopt in stages through the progressive adaptive approach.

The design allowance given in Table 45 is for the design of new coastal structures with paved land behind. For the design of new coastal structures with unpaved land behind, which is not common in nature, designers are advised to add the figures of 0.01m and 0.05m for 2050 and 2090, respectively, to the design allowance given in Table 45.

For extreme environmental conditions, the operations such as pedestrian and vehicle movements commonly cease at a marine structure. However, for the exceptional case when there is personnel or vehicle congregating at or near the marine structure under extreme environmental conditions, designers should determine the design allowance by considering the permissible overtopping rates for personnel and vehicles as stipulated in Section 5.3.2 of the Port Works Design Manual : Part 4 – Guide to Design of Seawalls and Breakwaters.

2.10 Increase in Design Extreme Sea Level due to Climate Change Effect

With reference to Intergovernmental Panel on Climate Change (IPCC) 6th Assessment Report (AR6), the **increase in design extreme sea level due to climate change effect**¹ in Year 2100, has taken into account the very high greenhouse gases emissions scenario. In the projection², apart from rise in mean sea levels due to climate change and increase in storm surge due to climate change, design allowance with progressive adaptive approach to enhance climate resilience have been considered. As illustrated in Table 46, the **increase in design extreme sea level due to climate change effect** in Year 2100 for 1 in 100 year return period is increased from around 0.5m with reference to IPCC 5th Assessment Report (AR5)³ to around 1.2m (ranging from about 1.1m to 1.4m for seven tide stations). This manual takes the results of IPCC AR6 on board in advising the enhanced requirements to combat climate change for designing coastal structures.

¹ The updated projection for the rise in mean sea levels due to climate change is tabulated in Table 42 of the Corrigendum No. 1/2022. The projections of storm surge increase due to climate change and design allowance with progressive adaptive approach to enhance climate resilience are respectively tabulated in Tables 44 and 45 of the Corrigendum No. 1/2022 of the PWDM.

² This is the summation of the components of **rise in mean sea levels due to climate change, storm surge increase due to climate change** and **design allowance to enhance climate resilience**. Progressive adaptive approach may be adopted in the design of the permanent coastal defense structure to cater for the portion of design allowance.

³ As tabulated in Table 42 in Corrigendum No. 1/2018 of the PWDM, the rise in mean sea levels due to climate change for Hong Kong was about 0.5m in Year 2100, taking into account medium greenhouse gases emissions scenario with reference to IPCC AR5.

3. OPERATIONAL CONSIDERATIONS

3.1 General

This chapter gives guidance on general aspects such as the design life of structures, ship data, requirements of approach channel and other operational considerations.

Many of the operational requirements of marine works and structures are specific to their particular functions. Appropriate advice should be obtained from the client or the operator, Director of Marine, Commissioner of Transport, other concerned government departments and parties as appropriate on all operational matters.

3.2 Design Life

The design life of a structure is taken to be its intended useful life, and will depend on the purpose for which it is used. The choice of design life is a matter to be decided in relation to each project. Unless special circumstances apply, the design life should be taken to be 50 years for all permanent marine structures covered by this Manual. This does not necessarily mean that the structure will continue to be serviceable for that length of time without adequate inspection and maintenance. Rather, regular inspection and, where necessary, repair are required under competent direction to ensure the stability and serviceability of the structure. In view of the variable and often unpredictable character of the forces to which marine structures are subjected, it is frequently unrealistic to expect substantial cost savings to result from attempting to design them for short lives. Generally, greater overall economy will be achieved by choosing simple robust concepts and appropriate reliable construction procedures.

Where special circumstances apply, the determination of the design life should take into account the following aspects :

- Nature and purpose of the project.
- Effects of factors which act against the stability and functions of the structure, including fatigue loading, corrosion, marine growth and soil strength reductions, and the corresponding maintenance effort required to ensure that the stability and functional requirements of the structure can still be met.
- Probability level that particular limit states or extreme events will occur during the design life.
- Cost benefit of the design life being considered, including an assessment of the

capital cost and overall maintenance cost of the structure together with any associated replacement cost required.

- Impact on the design life due to future developments, changes in operational practices and demands.

The probability level that an extreme event will occur is related to the design life and return period. Design life and return period are not the same and should not be confused. An event with a return period of T_R years or longer is likely to occur on average once in T_R years. The relationship among the probability level, design life and return period is given in Figure 11. Recommended return periods are covered in other sections or parts of this Manual.

3.3 Ship Data

Where possible, details and dimensions should be obtained from the Director of Marine, the client, owners and operators of the vessels to be accommodated, and those likely in the anticipated lifetime of the structure. Vessel characteristics which should be considered include type, size and shape, ship handling requirements, cargo or passenger handling requirements, and vessel servicing requirements. A definition sketch of the typical dimensions of the vessels is given in Figure 12.

Basic characteristics of local vessels taken from the Local Craft Registry provided by the Director of Marine are given in Table 36. Basic characteristics of the vessels owned by major ferry operators are given in Table 37. All values should be checked with the Director of Marine, concerned government departments and the ferry operators as appropriate before being used for design purposes. Information on other vessels using Hong Kong as a port of call should be sought from the appropriate authorities when required.

3.4 Current Conditions

Reclamation, dredging works and major sea defense such as breakwaters may cause changes in the pattern of tidal flow and consequently affect navigation, mooring and berthing forces, siltation and water quality in the vicinity of these marine works, and possibly some distance away from the site. During planning of the project, advice should be sought from the Civil Engineering Department and Environmental Protection Department on whether detailed mathematical modelling studies will be necessary, and Marine Department on the current

conditions for navigation and other vessel operations such as berthing and mooring.

3.5 Berth Conditions

Acceptable wave conditions at berths for ferries and public vessels or within cargo handling basins and typhoon shelters can only be determined after consultation with the Director of Marine and ferry or other vessel operators. Guidance on acceptable wave conditions for moored vessels is given in Sections 30 and 31 of BS 6349: Part 1 (BSI, 2000).

3.6 Typhoon Shelters

Typhoon shelters in Hong Kong are to provide shelter for vessels not exceeding 50 m in length under extreme wave conditions in typhoons. The recommended wave heights under extreme wave conditions should not exceed the following criteria :

<i>Vessel Length</i>	<i>Significant Wave Height</i>
Less than 30 m	Less than 0.6 m
30 m to 50 m	Less than 0.9 m

It should be noted that the recommended design criteria should be taken only as the target design values instead of the absolute allowable values. Localized exceedance of the design values may be permitted with due consideration of the site condition and the layout of the mooring areas within the typhoon shelter in consultation with the Marine Department.

3.7 Approach Channels

The depth and width of approach channels should be specified or approved by the Director of Marine. The required depth of channels can be calculated taking into account the following factors :

- Loaded draft of design vessel.
- Tidal variations.
- Wave induced motions of the vessel.
- Vessel squat and trim.
- An empirical factor giving an under-keel clearance to facilitate manoeuvrability,

economic propeller efficiency and a factor of safety.

The width of the channel, defined as the width at the dredged level, should be determined according to the following factors :

- Beam, speed and manoeuvrability of the design vessel.
- Whether the vessel is to pass another vessel.
- Channel depth.
- Channel alignment.
- Stability of the channel banks.
- Winds, waves, currents and cross currents in the channel.
- Availability of navigational aids.

The above factors are covered in detail by PIANC (1997).

Where the bottom of the channel consists of mud, it is usual in international ports to define the depth for navigation as being that between low water level and the level at which the density of the bottom sediment is equal to or greater than 1200 kg/m^3 , since research elsewhere has shown that the mud layers of lower density do not significantly impede the passage of a ship. The general practice to determine such a level in local port condition is to use an echo sounder of 200 kHz to 220 kHz which, by experience, is able to identify the seabed of density of 1200 kg/m^3 in most cases for safe navigation.

When planning the location of approach channels, and approaches or fairways in general, account should be taken of future siltation and maintenance. Consideration may be given to dredging to a depth greater than the minimum required navigation depth, with the intention of eliminating the need for maintenance dredging in the first few years after completion of initial dredging. Estimation of the amount of siltation within the channel may be determined from sedimentation field measurement and mathematical modelling as described in Section 2.8.

3.8 Navigation Aids

Aids to navigation are used to mark limits of structures such as piers, seawalls, breakwaters and dolphins, channel entrances, boundaries and turns, and hidden dangers such as shoals and rock outcrops, to act as a guide for vessels and to assist with their safe movement. The type, size, location and details of fittings and fixtures for navigation aids should be to the requirements of the Director of Marine.

General information and locations of existing navigation aids in Hong Kong waters which may be referred to in design can be found on the nautical charts published by the Hong Kong Hydrographic Office (see Section 2.3). The definitions of symbols, terms and abbreviations used on the nautical charts can be found in Hong Kong Chart 1 published by the Hong Kong Hydrographic Office (HKHO, 1997).

3.9 Critical Infrastructure

To improve the resilience of Critical Infrastructure (CI) in general, the marine CI such as piers and breakwaters and coastal protection works of CI are required to be designed for extreme environmental events with return periods of about 200 years. A CI is classified based on the three key principles as follows:

- Long recovery time upon hazard impact means the operation of infrastructures could not be resumed in short to medium term after the impact of climate-related hazards, or
- Non-substitutability is the reliance on the infrastructure to serve its function for the community. Some CI will be more critical if they are not easily substituted or replaced. The function(s) of CI could not be met by alternative means, or
- Disruption to territorial/regional wide service/daily life or economic impact is a “socio-economic” factor and thus it reflects the criticality of infrastructure to people and economic activities. People movements or economic activities can be considered in multiple hierarchies in the increasing sequence from local, district, regional to territorial.

4. GEOTECHNICAL CONSIDERATIONS

4.1 General

This chapter gives general comments and guidance on geotechnical investigation during the planning and design of a marine works project. For details of geotechnical investigation, the following documents issued by the Geotechnical Engineering Office should be referred to as appropriate :

- Geoguide 1 : Guide to Retaining Wall Design (GEO, 2022).
- Geoguide 2 : Guide to Site Investigation (GEO, 2017a).
- Geoguide 3 : Guide to Rock and Soil Descriptions (GEO, 2017b).
- Geospec 3 : Model Specification for Soil Testing (GEO, 2017c).
- GEO Technical Guidance Note No. 41 (TGN 41) – Amendments to British Standards References in Technical Guidance Documents for Migration to Eurocodes (GEO, 2014).

Where necessary, advice from the Geotechnical Engineering Office should be sought.

4.2 Marine Geology and Characteristics

(1) Sources of Geological Information

An understanding of the marine geology is useful in the design of the foundation of marine works. Information about site geology in Hong Kong can be obtained from the following documents published by the Geotechnical Engineering Office :

- Hong Kong Geological Survey Memoirs No. 1 to 6
(GCO, 1986 to 1990; GEO, 1995 to 1996)
- Hong Kong Geological Survey Sheet Reports No. 1 to 5
(GEO, 1992 to 1996)
- The Pre-Quaternary Geology of Hong Kong
(GEO, 2000a)
- The Quaternary Geology of Hong Kong
(GEO, 2000b)

These documents are accompanied by geological maps varying from Hong Kong-wide

1:20,000 and 1:100,000 scale to area specific 1:5000 scale for selected parts of Hong Kong. These sources of geological information will assist in the planning of the marine ground investigation and interpretation of the investigation results.

(2) Typical Offshore Subsoil Profile

Details of the offshore subsoil distribution and characteristics in Hong Kong are given in GEO (2000b) and a summary of the typical subsoil profile is given in the following paragraphs.

In Hong Kong, the typical offshore subsoil profile consists of a sequence of soft to very stiff transported sediments, which may be up to 100 metres thick, overlying in-situ rock in various states of weathering. The offshore transported sediments have been subdivided into four geological groups or formations, the Hang Hau Formation, the Sham Wat Formation, the Waglan Formation, and the Chek Lap Kok Formation. The distribution and sedimentary characteristics are summarized in Table 38 and a schematic diagram showing the general sequence of these geological formations is given in Figure 13.

Marine deposits of the Hang Hau Formation form the seabed over most of Hong Kong waters. The formation consist of a fairly uniform deposit of very soft to soft, normally consolidated, olive grey, clayey silts that contain shells and lenses of fine sand. These deposits are commonly referred to as marine mud. However, the formation becomes sandy towards the base, particularly in eastern waters where the lowest deposits represent the sandy infilling of tidal channels. At the seabed, in zones of strong currents such as the tidal channels of Urmston Road and Kap Shui Mun, the Hang Hau Formation deposits become sandy. In the deepest parts of the channels the deposits may be absent with rock exposed at the seabed.

In central and northeastern waters, the Hang Hau Formation directly overlies the Chek Lap Kok Formation, a mixed succession of clays, silts, sands, gravels and cobbles that may be uniform or poorly sorted. The assorted sediments that make up the Chek Lap Kok Formation are predominantly of alluvial origin, with complex geometrical relationships that reflect their origin as river channels and floodplains. Eroded channels, ranging in width from a few metres to several hundred metres and up to 20 metres deep, characterize the surface of the Chek Lap Kok Formation. This irregular topography is important when determining the base of the Hang Hau Formation for dredging or foundation purposes.

In western and southwestern waters, the marine Sham Wat Formation occurs between the Hang Hau Formation and the Chek Lap Kok Formation. The Sham Wat Formation

sediments are typically soft to firm, normally to slightly over-consolidated, light grey silty clays with thin sand bands. They differ in appearance from the Hang Hau Formation being lighter grey in colour with white patches of decayed shells and orange yellow oxidised mottles indicating subaerial exposure and weathering of the sediments. They also have a higher clay content, a slightly higher shear strength, and a lower moisture content than the Hang Hau Formation.

In southeastern waters, the Hang Hau Formation directly overlies the Waglan Formation, which is in turn underlain by the Chek Lap Kok Formation. The Waglan Formation comprises a generally firm, normally to slightly over-consolidated, dark olive grey, clayey silt with shells that is similar in appearance to the Hang Hau Formation. However, the Waglan Formation has a slightly higher shear strength and lower moisture content. The formation becomes sandy at the base with interbedded shelly sand and clayey silt. In a small area of southeastern waters, a restricted occurrence of the Sham Wat Formation underlies the Waglan Formation.

(3) Behaviour of Marine Mud

The presence of soft marine mud underlain by highly variable alluvial deposits requires that particular attention be paid to the site geology when designing marine works. The properties of the marine mud have been studied extensively in recent years and are shown in Table 39 (Ho & Chan, 1994). When the soft mud is loaded, the increase in external shear and vertical stresses will cause deformation leading to stability problems and foundation failure if the deformation becomes excessive. In a reclamation where the soft mud is left in place, mud waves may develop if the loading is uneven or is applied too quickly. Consequently, careful site control is required to avoid rapid or irregular fill placement that may result in excessive soil displacement and possibly successive slip failures. For foundations of marine structures, the stability during and after construction must be checked. Soil improvement techniques, piled foundations to transfer loads below the soft layers, or dredging and filling with granular material can be used to improve the stability. For environmental reasons, non-dredge solutions should be employed as far as possible. The correct choice and effective implementation of the fill placement and foundation methods, apart from cost, programming and technical factors, relies heavily on a sound understanding of the strength properties of the underlying sediments which can only be obtained through a comprehensive geotechnical investigation.

An increase in vertical stress will also induce an excess pore water pressure in the sediments, which will gradually dissipate as the pore water drains out. This process is accompanied by

the consolidation settlement of the soil, which takes place until the excess pore water pressure has completely dissipated. However, even after the excess pore water pressure has dissipated, settlement may continue for many years at a gradually decreasing rate. This phenomenon is commonly termed secondary consolidation. Settlement problems, such as differential settlement, may arise in a reclamation or marine structure if significant amount of settlement occurs after the works are completed. Hence, it is essential to ascertain the settlement parameters of the soils in order to ensure that any residual settlement, due either to primary or secondary consolidation, will not affect the future development of the reclamation or the operation of the marine structures.

Details of stability and settlement analysis for seawalls, breakwaters and reclamation are given in Part 3 and Part 4 of the Manual :

- Part 3 – Guide to Design of Reclamation.
- Part 4 – Guide to Design of Seawalls and Breakwaters.

4.3 Determination of Soil Properties

Geotechnical investigations should begin with a desk study in which all existing site investigation data and geological information are reviewed, lead up to a thorough site reconnaissance, and culminate in one or more stages of ground investigation. From in-situ and laboratory tests of the sediments, the engineering design parameters can be determined. The procedures for carrying out geotechnical investigations and laboratory soil testing are described in [Geoguide 2 \(GEO, 2017a\)](#) and [Geospec 3 \(GEO, 2017c\)](#). Recommendations for the description of Hong Kong rocks and soils for engineering purposes are given in [Geoguide 3 \(GEO, 2017b\)](#).

(1) Layout of Investigation

The extent, layout and final depth of the ground investigation should be determined with reference to the nature of the proposed marine works, the geology of the site, the findings of the desk study, and from site reconnaissance observations undertaken at periods of both low and high tides. Where weak and compressible materials will be encountered, the ground investigation should penetrate to a sufficient depth preferably into the underlying weathered rock to allow an estimate of the founding depth, the location of any potential shear failure surface, and the amount and rate of settlement. For piled structures such as a pile-supported deck pier, the investigation should be continued until a suitable pile-bearing stratum has been

reached and is proved to be of adequate thickness. The depth of exploration should be at least 5m below the founding level of the piled foundation or 2.5 times the diameter of the piles proposed (GCO, 1987), whichever is deeper.

Guidance on the determination of the location and spacing of the points of exploration is given in Chapter 10 of *Geoguide 2* (GEO, 2017a). The points of exploration may include a combination of borehole locations and points of in-situ tests such as cone penetration tests (see paragraphs below). General indication on the spacing of the points of exploration for different types of marine works are given as follows :

- Piers or Jetties : 10 m to 30 m
- Seawalls, breakwaters or reclamation : 50 m to 150 m

For works which are small in plan area, a minimum of three points of exploration should be required if possible. In cases where the soil stratification is complex, or where buried obstructions are present or suspected, or where there are uncertainties on the information, additional boreholes should be sunk as necessary to confirm the soil strata and properties. It should be noted that the required spacing of points of exploration is dependent on factors such as types and functions of proposed marine works, site location and soil complexity. Hence, the above spacing should not be treated as the absolute maximum or minimum allowable values. For large offshore projects requiring a staged ground investigation, a marine geophysical survey carried out during the first stage will provide useful information about the distribution of sediments and serve as a reliable basis for the optimum location and spacing of boreholes, in addition to identifying those areas that will require more detailed investigation (see *Geoguide 2* (GEO, 2017a)). For pile foundation works, reference should also be made to WBTC 22/2000 (WB, 2000).

(2) Soil Testing

The engineering properties of the soils can be assessed by means of a range of in-situ or laboratory tests.

Methods of in-situ testing commonly used include the Standard Penetration Test, Vane Shear Test and Cone Penetration Test. The Standard Penetration Test, which is carried out during drilling, records the number of blows that are required to drive a standard sampler a distance of 300 mm below the base of the borehole. Blow count provides an indication of the relative strength of the soils encountered. The Vane Shear Test measures the torque required to rotate a calibrated vane in the sediments, from which the measured torque value can be related to the

shear strength of the soil. This test is very useful for determining the in-situ undrained strength of the marine mud and clayey alluvial deposits. However, if the sediments are sandy or contain shells, the vane shear results should be interpreted with caution. In addition, there exists strong evidence that in-situ vane shear tests (e.g. Clause 4.4 of BS1377:Part 9:1990) give values too large for design. The use of proper reduction factor for the in-situ vane shear strength as proposed by Bjerrum (1972), Ladd et al (1977) and Aas et al (1986) should be noted. The Static Cone Penetration Test generally provides a rapid means of determining the soil type, the soil profile, and the soil strength by measuring the resistance encountered by the tip of the penetrating cone. The Static Cone Penetration Test uses a 60° cone and friction sleeve (see Clause 3.1 of BS1377:Part 9:1990). This test is also used as a rapid and economical means of interpolating between boreholes. Although it may be possible to estimate the type of soil through which the cone is passing, it is preferable to carry out the test in conjunction with other means of determining the nature of the soil.

Details of typical laboratory tests are given in [Geospec 3 \(GEO, 2017c\)](#). As a general requirement, soil classification, shear strength and consolidation tests (such as the triaxial compression test and the oedometer test) are commonly specified for marine ground investigations. Undisturbed samples for laboratory tests, such as the determination of the strength and settlement characteristics of the sediments, are usually obtained as piston samples from soft marine mud and Mazier samples from the firmer alluvial deposits. Piston and Mazier samples may not necessarily be high-quality undisturbed samples. A sufficient number of samples should be taken to assess the variations in both the characteristics of the sediments and the associated geotechnical design parameters. In order to cover all possible variations, the testing schedule should be flexible. The designer should prepare an initial testing schedule that is continually modified as observations are made and new information is obtained from the ground investigation. Wherever possible, additional samples should be specified for duplicate tests to check the consistency of the test results.

The quality of the test results depends on the sample quality. Therefore, close field supervision is required to ensure that careful drilling and sampling techniques are employed to yield high quality test samples. Tables 8 and 9 in [Geoguide 2 \(GEO, 2017a\)](#) provide guidance on the sample quality that is required for different sampling procedures and soil materials.

It should be noted that shear strength and consolidation tests normally take a fairly long period to complete, especially for soils like marine mud which has low permeability. Adequate time should be allowed for the laboratory testing programme during project planning.

Table 40 lists the in-situ and laboratory tests that can be carried out during marine ground investigations, together with the type of information provided by the tests. Additional tests such as particle size distribution, Atterberg limits, moisture contents and soil density tests are usually requested to provide information on the general properties of the soils, correlation between soils in different locations, and further details to support the geotechnical parameters. For silty or clayey soil, information on the undrained shear strength is necessary to assess the stability of marine structures such as gravity or sloping seawalls.

It should be emphasized that the specified laboratory testing conditions should resemble, as closely as possible, the field conditions in which the works or structures will be constructed and operate under various stages. The initial state of the samples as well as the state of the soils in the construction and operation conditions should be clearly specified. Adequate number of samples should also be tested under different stress conditions in order to determine the shear strength and settlement parameters of the soils at different locations and depths.

4.4 Determination of Rock Properties

Typical ranges of values of the uniaxial compressive strength of the most commonly encountered rocks in Hong Kong are given in Table 11 of [Geoguide 1 \(GEO, 2022\)](#). Usually, the strength of the intact bedrock is not an important consideration in the design of breakwaters, gravity seawalls and reclamations. For marine structures supported by piles founded on rock, it is necessary to check whether the rock strength is adequate to resist the loads transmitted from the piles. The rock strength may be assessed approximately by identification tests (GCO, 1988). Where necessary, it can be measured by uniaxial compression tests on rock cores or point load index tests on rock specimens. It should be noted that, depending upon the rock type, the strength of Grade III rock (moderately decomposed rock) is very variable and can be quite low. In such case, the rock strength should be selected conservatively in the design. For further details about the determination of rock strength parameters, reference should be made to Chapter 5 of [Geoguide 1 \(GEO, 2022\)](#).

5. LOADING CONSIDERATIONS

5.1 General

This Chapter describes the loading conditions which should be considered in the design of marine structures and includes information on the loads to be taken into account. Guidance is given on the selection of relevant design parameters and methods of calculation to derive the resulting direct forces on structures, taking into account the nature and characteristics of the structures.

In Hong Kong, marine structures are generally designed to British Standards (BS), in particular, following the guidance and recommendations given in relevant parts of BS 6349 – Maritime Works: Code of Practice. This BS together with the relevant Eurocodes (EC) and their UK National Annexes (UK NA) should be adopted for the design of marine structures.

Particular attention should be paid that the following terms used in the EC are different from those used in this Manual:

<u><i>This Manual</i></u>	<u><i>Eurocodes</i></u>
Design loads or forces	Actions
Dead load	Permanent action
Imposed load (live load)	Variable action
Other loads except dead load (such as wind load, wave load, current load, berthing load and mooring load)	Variable actions
Load condition	Design situation
Load combination	Combination of actions

In addition to dead loads, superimposed dead loads, hydrostatic loads and soil pressures, the other forces which may act on marine structures are environmental loads, arising from such natural phenomena as winds, temperature variations, tides, currents, waves and earthquakes, and those imposed loads due to operational activities. General imposed loads cover live loads from pedestrians, vehicles, cargo storage and handling. Vessel imposed loads cover berthing, mooring and slipping.

Unless stated otherwise, the design loads given in this Chapter are unfactored.

5.2 Loading Conditions and Combinations

The structure as a whole, or any part or section, should be designed and checked for at least the loading conditions given below. If it is expected that other loading conditions could be critical, they should also be investigated. Various types of load should be combined in a manner consistent with the probability of their simultaneous occurrence.

5.2.1 Normal Loading Conditions

These loading conditions are those in which normal operations continue unaffected by environmental conditions. A combination of the following should be considered :

- Dead loads.
- Superimposed dead loads.
- Live loads due to normal working operations (the most severe arrangement likely to occur simultaneously).
- Vessel imposed loads (berthing and mooring).
- Normal environmental loads (winds, currents and waves).
- Soil pressures.
- Hydrostatic loads.
- Variation in loads throughout design life as a result of climate change.

Guidance on the calculation of environmental loads associated with normal working operations is given later in this Chapter under each type of loading condition. It should be assumed that maximum imposed live loads can occur simultaneously with maximum vessel imposed loads from either berthing or mooring, whichever gives the most severe effect. It is possible for mooring loads to occur at the same time as berthing for certain size and geometry of the structure such as a jetty allowing berthing on one side and mooring on the other side. In this latter case, the most severe combination of berthing and mooring loads should be determined by the designer and this combination assumes to occur simultaneously with maximum imposed live loads.

For normal environmental loads, it should be assumed that maximum loads from winds, currents and waves can occur simultaneously. All directions should be considered when assessing the most severe effects from these loads.

Variations in hydrostatic loads and normal wind and waves environmental loads may be expected over the design life of the structure and structural performance as well as overtopping should be checked at the beginning and end of the design life of the structures.

5.2.2 Extreme Loading Conditions

These loading conditions are associated with the most severe environmental conditions which the structure is designed to withstand. It is assumed that under these conditions most normal operations, such as vessel berthing and mooring, pedestrian and vehicle movements, and cargo storage and handling, will have ceased. A combination of the following should be considered :

- Dead loads (same values as for Normal Loading Conditions).
- Superimposed dead loads (these may be different from Normal Loading Conditions).
- Reduced live loads (if any at all) due to continuing operations.
- Reduced vessel-imposed loads (if any) due to continuing operations.
- Extreme environmental loads (winds, currents, waves and temperature variations).
- Soil pressures (these may be different from Normal Loading Conditions due to variation of water table).
- Hydrostatic loads (in some cases, these will be different from Normal Loading Conditions, e.g., due to difference in water levels).
- Variation in loads throughout design life as a result of climate change.

It should be assumed for extreme environmental loads that maximum effects from winds, currents and waves can occur simultaneously, but maximum effects from temperature variations should be considered separately. Vessel-imposed loads can be ignored under extreme environmental conditions from winds, currents and waves, as these will occur during tropical cyclone conditions when normal vessel movements will have ceased. However, vessel-imposed loads should be combined with maximum effects from temperature variations. Guidance on live loads to be considered under extreme environmental conditions from winds, currents and waves is given in later sections of this chapter. Normal maximum live loads should be combined with maximum effects from temperature variations, as these variations will not occur during tropical cyclone conditions.

Unless stated otherwise, the extreme environmental conditions for structures having a design life of 50 years should be taken as those having return periods of 100 years. Where special circumstances apply, resulting in a shorter or longer design life, the return period should be adjusted accordingly. The relationship of the return period and the design life is shown in Figure 11.

5.2.3 Temporary Loading Conditions

Temporary Loading Conditions are those which arise during construction, towing, installation or the carrying out of unusual but foreseeable operations, such as the application of a test load. For these conditions, a combination of the appropriate dead and maximum temporary loads, together with the associated environmental loads, should be considered. Temporary design and environmental conditions should be appropriate for the location, and for the time of year, when the construction or operation will be carried out. **The effects of climate change on Temporary Loading Conditions need not to be considered in design if this is not appropriate.**

5.2.4 Accident Loading Conditions

Accident Loading Conditions are those which occur during accidental impact by a vessel. For these conditions, a combination of dead, superimposed dead and hydrostatic loads, soil pressures, live loads and normal environmental loads, together with the appropriate accident berthing load, should be considered. Guidance on accident berthing loads is given later in this Chapter. The above combination is to some extent artificial, as an accident can occur at a time of normal or extreme environmental loading conditions. However, it is not normally necessary to combine accident berthing loads with maximum imposed loads and extreme environmental loads because of the low probability of their simultaneous occurrence. The need for checking of accident loading conditions will depend on :

- Importance of the structure.
- Location with respect to normal ferry routes and fairways.
- Degree of exposure to adverse environmental conditions.
- Expected degree of use if the structure is a pier.
- Susceptibility to damage of the type of design used.

Public and ferry piers should generally be designed or checked for accident loading conditions. For such accident loading conditions, damage to minor structural members which can be readily repaired, and to such items as fenders, can be accepted at the discretion of the designer in consultation with the maintenance authority. **Variation in water level at the beginning and end of design life of the structure as a result of climate change should be assessed when considering Accidental Loading Conditions.**

5.3 Dead Loads

The dead load is the weight of the structural elements of the structure, including any substructure, piling and superstructure. The weight of the structure is its weight in air. Where parts are wholly, partially or intermittently immersed in water, upthrust on those parts should be calculated separately, as recommended in Section 5.7.

5.4 Superimposed Dead Loads

The superimposed dead load is the weight of all materials imposing loads on the structure that are not structural elements, and should include surfacing, fixed equipment, fenders, bollards, handrails, ladders, walkways, stairways, services, fittings and furniture. For all loading conditions, the possibility of any of the superimposed dead loads being removed should be considered.

5.5 Live Loads

5.5.1 Live Loads on Different Types of Structures

The imposed live loads include all loads which the structure has to withstand except dead, superimposed dead, hydrostatic, soil, vessel-imposed and environmental loads, and should be the greatest applied load likely to arise from the intended use or purpose of the structures. The minimum imposed live loads that should be applied in a design are recommended in the following paragraphs, and should be adjusted to take into consideration the use of the structures and the types of installations on them.

(1) Public Piers

The live loads for the decks of public piers, to include for the movement of pedestrians, hand luggage, ship provisions and temporary stacking, should be taken as 10 kPa. Where emergency vehicular access by an ambulance, police vehicle and/or fire engine as appropriate is required, the following additional requirements should be satisfied :

- Concentrated load to be applied on plan over any square with a 300 mm side should be greater than 75 kN.
- Total load to be applied on beams, uniformly distributed over span, should be

greater than 150 kN.

Where general access for pedestrians is provided to the roof, the live load should be taken as 5 kPa.

(2) Ferry Piers

The live loads for pedestrian ferry piers should be no less than those given above for public piers, but should in addition be checked and agreed with the prospective ferry operators. The live loads for vehicular ferry pier waiting areas and ramps will depend on the types of vehicles allowed or expected to use the services, and should be agreed with the prospective ferry operators.

(3) Other Piers

The live loads for other piers should be determined after consultation with the prospective users, taking into account the proposed use, possible cargo storage, cargo handling equipment and vehicular access.

(4) Dolphins

The live loads for dolphins should be taken as 5 kPa.

(5) Seawalls

The live load on the area of the land behind the seawalls should be determined taking into account the designated land use, and should be taken as follows :

- Footpaths, cycle tracks, open play areas and the like : 10 kPa
- Roads and carriageways (normal traffic) : 20 kPa

When assessing the loading conditions behind seawalls, the effect of temporary loads, such as those due to surcharge preloading in a new reclamation, should also be investigated in the design.

(6) Breakwaters

The live load on the crest of the breakwaters should be no less than those given above for

seawalls, taking into account the uses and operations on the breakwaters.

5.5.2 Determination of Continuous Live Loads

Guidance on the determination of the live load due to continuing operations under extreme environmental conditions from winds, currents and waves, and of the live loads to be used in accident loading conditions referred to in Section 5.2, is given below.

(1) Live Loads under Extreme Environmental Conditions

The live loads due to continuing operations under extreme environmental conditions from winds, currents and waves may be taken as zero for piers and dolphins unless there is a specific need or requirement for the pier to be used during tropical cyclone conditions, e.g. for emergencies or storage. For seawalls, the maximum live loads on the adjacent land due to continuing operations under extreme environmental conditions may be taken as 50% of the live loads due to normal working operations under normal environmental conditions, provided that it can be ensured with reasonable certainty that the land behind the seawall will not be used for the storage or temporary stacking of materials. For other structures, the live loads due to continuing operations under extreme environmental conditions should be assessed by the designer. Normal maximum live loads should be considered to apply under extreme environmental conditions relating to temperature variations.

(2) Live Loads under Accident Conditions

The live loads to be used in Accident Loading Conditions for normal structures can be taken as 50% of the live loads due to normal working operations under normal environmental conditions. At the discretion of the designer, this percentage may be reduced to 25% for structures expected to be loaded infrequently, or increased to 75% for structures expected to have particularly heavy usage such as ferry piers on major routes with exceptionally frequent services.

5.6 Tides and Water Level Variations

Information on tides, the mean and extreme range of still water levels is given in Section 2.2. Such information is required for the evaluation of :

- Overtopping.

- Hydrostatic pressures, including buoyancy effects.
- Soil pressures.
- Levels of action of mooring, berthing and wave forces.

In addition, the effect of waves and wave run-up should be considered in relation to overtopping and hydrostatic pressures. Variations in tides, mean and extreme ranges of water levels may be expected over the design life of the structure and performance in relation to the four bullet points listed above should be checked at the beginning and end of the design life of the structures.

For structures with a design life of 50 years and for the loading conditions referred to in Section 5.2, the range of water levels that should normally be considered are given as follows :

<i>Loading Conditions</i>	<i>Water Levels</i>
Extreme	From mean lower low water level to 100-year return period water level
Normal	From mean lower low water level to 2-year return period water level
Accident	From mean lower low water level to 2-year return period water level
Temporary	Range of water levels to be assessed by designers for each individual case

For structures where a different design life applies, the return period for extreme loading conditions should be adjusted accordingly.

Structures should be designed to withstand safely the effects of the range of still water level referred to above for each loading condition. It should be noted that for different types of structure, different loading cases, and different conditions, the critical still water level may be the minimum, maximum or some intermediate level; the full range must be investigated by the designer.

5.7 Hydrostatic Loads

When considering the effects of buoyancy, it is preferable to represent the buoyancy and gravitational loads as separately applied loading systems. In this way, the effect of changes

in water level can be seen more clearly, and it is possible in limit state design to apply different load factors to dead loads and hydrostatic loads as appropriate. The determination of hydrostatic loads should take into account water level variations and ground water profiles mentioned in Section 2.2.5, Section 5.6 and Section 5.8 respectively. Buoyancy forces due to variation in water level at the beginning and end of design life of the structure as a result of climate change should be considered.

For calculating the hydrostatic loads, the freshwater and seawater densities may be taken as 1000 kg/m^3 and 1025 kg/m^3 respectively.

5.8 Soil Pressure and Ground Water Profiles

Guidance on the calculation of soil pressures is given in *Geoguide 1 (GEO, 2022)*. For the purposes of calculating soil pressures :

- Water levels should be derived as described in Section 5.6.
- Ground pore water pressures should be determined with reference to tidal range, soil permeability, drainage provisions, and any artesian and sub-artesian ground water conditions.
- Allowance should be made for reduced passive resistance due to overdredging or scour.

Variations in scour in front of the structure should be assessed due to changes in water levels and wave conditions expected due to climate change over the design life of the structure.

In the case of a seawall adjoining reclaimed land, the wall together with the backfill up to a vertical plane above its heel (i.e. the virtual back) can be treated as a monolithic block for the purpose of stability checking. Active soil pressures may be assumed in the calculations and suggested maximum values of mobilized angle of wall friction for active pressure calculations are given in Table 14 of GEO (1993a). Passive resistance in front of the toe of the structure can be neglected for typical gravity type seawalls such as concrete blockwork seawalls resting on a rubble mound.

The ground water condition is a critical factor in stability analysis. Designers should note that ground water profiles are site-dependent. If possible, it is recommended that the design water pressures should be evaluated from field observations and a detailed analysis considering :

- Tidal variation at the seaward side of the seawall.
- Water inflow from landward and from seaward sides of the seawall.
- Rate of overtopping water under severe wave climate.
- Permeability of water draining behind, through and under the structure.
- Surface and back drainage provided to cater for surface and ground water.

Variations in tides, mean and extreme ranges of water levels may be expected over the design life of the structure and these should be included in the design for the beginning and end of the design life of the structures.

In relatively simple conditions, the ground water profiles illustrated in Figure 14 may be used as a reference. Where the land behind the seawall is paved, the flow from landward sources is negligible, and adequate surface and back drainage behind the structure are provided, the ground water profile in the fill behind the seawall may be taken as almost horizontal at a level higher than the still water level. Unless there is clear evidence to the contrary, a tidal lag of not less than 0.7 m and 1.0 m above the still water level under normal loading conditions and extreme loading conditions respectively may be used in design.

In addition to the above water level lags, where the land behind the seawall is not paved and the fill is highly variable, the groundwater profile should take into consideration the worst credible ground water conditions that would arise in extreme events selected for design. Guidance on the determination of the worst credible water conditions are given in [Geoguide 1 \(GEO, 2022\)](#).

Where the flow from landward sources is significant, the effects of the ground water profile should be evaluated by field investigations.

5.9 Wind Loads

For the assessment of wind loads on marine structures and for the loading conditions referred to in Section 5.2, the following design wind pressures may be assumed :

<i>Loading Conditions</i>	<i>Design Wind Pressures</i>
Normal	1.2 kPa
Extreme	3.0 kPa
Accident	1.2 kPa

For Temporary Loading Conditions, the design wind pressure should be assessed by the designer for each individual case, taking into account the following points :

- The design wind pressure of 1.2 kPa for Normal and Accident Loading Conditions corresponds to a gust of about 44 m/s, which is the maximum gust expected to occur with a mean hourly wind speed of 17 m/s (33 knots). This by definition is the maximum mean hourly wind speed likely to occur while Tropical Cyclone Signal No. 3 is hoisted or within the first few hours of the hoisting of Tropical Cyclone Signal No. 8. The above assumes a gustiness factor (ratio between maximum gust and mean hourly wind speed) of about 2.6, which is not normally exceeded under Hong Kong conditions. For details of gustiness factors, reference may be made to Chen (1975) and Poon (1982).
- The design wind pressure of 3.0 kPa under extreme environmental conditions corresponds to a gust of about 70 m/s (136 knots), which is the maximum gust expected to occur with a return period of about 50 years in Hong Kong waters.

Wind forces on structures and elements of structures may be calculated in accordance with [Code of Practice on Wind Effects in Hong Kong 2019 \(BD, 2019\)](#).

5.10 Wave Loads

5.10.1 General

Wave loads on a structure are dynamic in nature, but when the design wave period is much higher than the structure's fundamental period, as will be the case for the vast majority of structures covered by this Manual, these loads may be adequately represented by their static equivalents. General guidance on dynamic responses and vibrations are covered in Section 5.15. The crest or trough of any design wave should be positioned relative to a structure such that the wave forces have their maximum effect on the structure. It should be noted that the maximum stress in elements of the structure may occur for wave positions, directions and periods other than those causing the maximum force on the structure and such effect should be considered in design. Allowance should also be made in calculations for the build-up of marine growth on the structures. Where no other information or site measurements are available, a uniform effective thickness of 100 mm of marine growth for all surfaces below mean sea level may be assumed.

5.10.2 Wave Conditions

The wave conditions that should be assessed in design should be jointly described with the water levels as these two variables are correlated (HKPU, 2000). Under the effect of climate change, the storm surge increase, with the same return period as the return period of the wave conditions shall also be taken into account. For typical marine works with a design life of 50 years, the following wave conditions, surge storm increases and water levels should normally be considered :

Loading Conditions

Waves, Storm Surge Increases and Water Levels

- | | |
|---|---|
| <ul style="list-style-type: none"> ● Extreme | <ul style="list-style-type: none"> ● Extreme wave condition and storm surge increase at 100-year return period and extreme water level at 10-year return period. ● Extreme wave condition and storm surge increase at 10-year return period and extreme water level at 100-year return period. ● Extreme wave condition and storm surge increase at 50-year return period and extreme water level at 50-year return period. ● Extreme wave condition and storm surge increase at 100-year return period and mean lower low water level. |
| <ul style="list-style-type: none"> ● Normal | <ul style="list-style-type: none"> ● Wave condition at tropical cyclone warning signal no. 3 or within the first few hours of the issuance of tropical cyclone signal no. 8 and maximum water level at 2-year return period. ● Wave condition at tropical cyclone warning signal no. 3 or within the first few hours of the issuance of tropical cyclone warning signal no. 8 and mean lower low water level. |
| <ul style="list-style-type: none"> ● Accident | <ul style="list-style-type: none"> ● Same as normal loading condition. |
| <ul style="list-style-type: none"> ● Temporary | <ul style="list-style-type: none"> ● Wave condition to be assessed by designers for each individual case. |

The extreme waves, storm surge increases and water level conditions given above for typical marine works refers to extreme environmental events with return periods of about 100 years.

For design of Critical Infrastructure, the following wave conditions, storm surge increase and water levels for the extreme loading condition should normally be considered :

*Loading Conditions**Waves, Storm Surge Increases
and Water Levels*

- Extreme
 - Extreme wave condition and Storm Surge Increase at 200-year return period and extreme water level at 10-year return period.
 - Extreme wave condition and Storm Surge Increase at 10-year return period and extreme water level at 200-year return period.
 - Extreme wave condition and Storm Surge Increase at 100-year return period and extreme water level at 100-year return period.
 - Extreme wave condition and Storm Surge Increase at 200-year return period and mean lower low water level.

The extreme waves, storm surge increases and water level conditions given above for Critical Infrastructure refers to extreme environmental events with return periods of about 200 years.

When wind data are used for determining the wave heights, the extreme wind speeds shown in Tables 12 to 30 may be used to estimate the wave heights under extreme loading conditions. In this connection, it may be assumed that the 100-year wind waves are generated by the 100-year winds, the 50-year wind waves by the 50-year winds, the 10-year wind waves by the 10-year winds and so forth. For the assessment of wave heights under present day normal and accident loading conditions, a mean hourly wind speed of 17 m/s, or the equivalent wind speed adjusted for duration, may generally be used. To obtain future wind speeds including the effects of climate change, this figure may be increased by the values provided in Table 43 from an assumed baseline year of 2010. The reason for selecting this particular mean hourly wind speed is given in Section 5.9. For temporary loading conditions, the designer should assess the design wave parameters for each situation, taking into account the likely wind speeds and water levels to be experienced.

In each loading condition, the effect of swells may be considered with reference to Table 34 in which the offshore wave data of Hong Kong are given. For assessing the wave conditions in normal loading and accident loading conditions, the 2-year wave data may be used in the absence of more realistic wave information. Similarly, for assessing the wave conditions in extreme loading condition, the respective wave data corresponding to the return period of the extreme wave conditions may be used.

It should be noted that for different types of structure, different loading cases and different conditions, the critical still water level may be the minimum, maximum or some intermediate level. For example, smaller waves at a lower sea water level may break near the shore while

those higher waves at higher sea water level may not break. The associated breaking waves of the smaller waves may represent a more critical condition to the structures than the higher non-breaking waves. **The full range of water levels including the effects of climate change and in addition to the water levels mentioned in the above paragraphs should be investigated by the designer.**

5.10.3 Wave Forces on Vertical Structures

Waves incident upon a long vertical surface may be reflected without breaking and a standing wave will be formed in front of the wall. In certain depths, relative to the wavelength and wave height, waves may break against the wall producing impulsive loading which may be very large over small surface area. The following paragraphs recommend methods to estimate the average wave pressures on a long structure.

(1) Wave Pressure under Wave Crests

The maximum wave pressure on a long vertical reflective wall may be estimated by the method of Goda as referred to in BS 6349:Part 1 (BSI, 2000). A summary of the method is given in Figures 15 and 16. The method deals with both the standing and breaking wave forces in a single formula. The formulae make use of the wave height parameter H_{\max} as the design wave height. The basic concept is to design the structure against the largest single wave force expected during the design sea state, assuming that the largest force could be evaluated with the highest wave in a wave group. Goda recommended that H_{\max} can generally be taken as $1.8H_{1/3}$ seaward of the surf zone, whereas within the surf zone the height is taken as the highest of the random breaking waves H_{\max} at the location of a distance equal to $5H_{1/3}$ seaward of the structure as given by the equations shown in Appendix A. The wave period to be used in the formulae can be taken as the significant wave period $T_{1/3}$.

A trapezoidal shape of pressure distribution is assumed along the face of the vertical wall. It should be noted that the water depth above the rubble foundation is measured from the top of the rubble layer but the wave pressure is exerted down to the bottom of the vertical wall.

The method of Goda also calculates the wave uplift pressure acting on the bottom of the structure in addition to the buoyancy due to displaced water below the design water level. A triangular distribution of uplift pressure under the structure is assumed as almost free drainage is provided by the rubble mound of the foundation.

(2) Wave Pressure under Wave Trough

When the trough of an incident wave makes contact with a vertical wall, the pressure exerted on the wall becomes less than the hydrostatic pressure under the still water level. As a result, the vertical wall experiences a net pressure seaward. The solution for wave pressure under a wave trough, in particular that of breaking waves, has not yet been fully developed. But as far as the pressure of standing waves is concerned, the wave pressure distribution under the trough may be determined according to the theory of Sainflou as given in Figure 17. The maximum wave height H_{\max} should be used as the design wave height in the calculation of wave pressures under wave troughs. Such a pressure will likely govern the stability of the structure against sliding and overturning seaward.

5.10.4 Wave Forces on Piles

Wave force due to non-breaking waves on a circular pile which does not obstruct wave propagation may be calculated from Morison's equation as the sum of a drag force and an inertia force. The method, summarized in Figure 18, is applicable for $D/L \leq 0.2$, where D is the pile diameter and L is the wavelength. Caution is given here, however, that the use of linear wave theory in evaluating the wave orbital velocity may lead to an underestimation of the wave force when the ratio of wave height to water depth or the wave steepness cannot be regarded small. It should also be noted that the crest elevation above the mean sea level is greater than $H/2$ because of the finite amplitude wave effect, where H is the wave height. Suggested values of the drag coefficient in the Morison's equation are shown in Figure 19 and a value of 2 is recommended for the inertia coefficient for circular piles.

For breaking waves, the Morison's equation may also be applied under the assumption that the wave acts as a water mass with high velocity on the pile without acceleration. The inertia coefficient may be taken to be zero whereas the drag coefficient may be increased to 1.75. This recommendation, however, is based on limited information. Breaking wave force generally occurs in very shallow water region (e.g. surf zone). Although the breaking wave force may be greater per unit length of the pile, the pile length subject to action of breaking waves is usually shorter in very shallow water area as compared to that in deeper water and this possibly results in a smaller total force. Hence, pile design may be governed primarily by vertical loads acting along the pile under such condition.

The design wave height may be taken as $2H_{1/3}$ seaward of the surf zone, whereas within the surf zone the height is taken as the highest of the random breaking waves H_{\max} at the location of a distance equal to $5H_{1/3}$ seaward of the structure as given by the equations shown in Appendix A. The wave period to be used in the formulae can be taken as the significant wave period $T_{1/3}$.

Care should be taken that for piles standing closer than about four pile diameters, the loading for the front piles standing side by side in rows parallel to the wave crest should be increased by the following factors (EAU, 1990) :

<i>Pile Centre-to Centre Distance</i>	<i>Factor</i>
2 x Pile Diameter	1.5
3 x Pile Diameter	1.25
4 x Pile Diameter	1.0

For the assessment of wave forces on piles, the area normal to the flow or wave propagation should include an allowance for marine growth. Where no other information or site measurements are available, a uniform effective thickness of 100 mm of marine growth for all surfaces below mean sea level may be assumed.

5.10.5 Wave Forces on Pile-supported Deck Structures

For some structures, it will be necessary to separate the structure into different elements and apply different theories to different elements in order to assess the total wave load on the structure. For a pile-supported deck structure consisting of a relatively open concrete deck supported on piles, the deck should be considered to consist of a solid concrete deck edge, with effective depth to be assessed by the designer, for which reflective conditions mentioned in Section 5.10.3 will apply if the deck length is sufficient. Below this solid concrete deck edge, wave loads on the piles should be assessed separately using Morison's equation. It should normally be assumed that maximum wave forces on the deck edge and piles can occur simultaneously. However, it should be noted that maximum wave forces may not occur simultaneously at all piles in a pile bent.

It is particularly important when assessing wave forces for pile-supported deck structures, where reflective conditions may apply for one part and Morison's equation for another part of the structure, to check wave forces for different still water levels. The critical still water level for wave loads on different elements of the structure will not always be the same, and will not always correspond to the critical water level for wave loads for the structure as a whole.

5.10.6 Wave Uplift

For a deck whose soffit is just above the still water level, incoming waves may exert impulsive uplift forces as the rising water surface hits the deck's soffit. The impulsive uplift is characterized by the relatively high magnitude but short duration. There have been some

instances of damage of open-type wharves with decks supported by vertical piles, in which the connecting parts between decks and piles were destroyed and the decks were uplifted while partially damaged. The access bridges between the decks and the earth retaining walls may be fallen down by the action of impulsive wave uplift. The magnitude of uplift intensity is hard to evaluate. Based on a study on wave absorbing seawall for the Victoria Harbour (HKU, 1998), the average uplift pressure on the deck soffit just above the still water level may be in the order of 1.3 to $1.7 \gamma_w H_{\max}$, where γ_w is the unit weight of seawater. However, the instantaneous uplift pressure may locally rise more than $10 \gamma_w H_{\max}$, but the equivalent static pressure for calculating stresses within the deck should be less than 4 times the hydrostatic head of the design wave height (OCDI, 2002).

5.10.7 Waves on Rubble Mound Structures

For rubble mound structures protected by rock armour or concrete armour units on the slope, the overall stability and the unit stability must be fulfilled for the structure to remain stable under wave actions. It is realized that damage to an armoured sloping structure is often a chain process by which failure of one element induces a series of failures. The stability of a single armour unit therefore becomes a prime interest for the stability of the entire structure.

In general, the design of rubble mound structure involves the determination of the size of the armour unit on the slope by means of some stability formulae instead of calculating the wave force on it. These stability formulae generally express the weight of an armour unit as a function of a number of factors such as wave conditions, slope of the structure, the permeability of the structure and the properties of the armour unit. Examples of these formulae include the Hudson formula and the Van Der Meer formulae. Guidance on the application of these formulae are given in Part 4 of the Manual – Guide to Design of Seawalls and Breakwaters.

5.11 Current Loads

5.11.1 General

Where no detailed information or records are available at a site, the design current velocity for Normal, Extreme, Temporary and Accident Loading Conditions may be taken as 1 m/s from the water surface to a depth of 15 metres below the water surface. Below 15 metres water depth, the current may be ignored. For most locations, particularly within the harbour area, the above will be conservative, as current forces are assumed to act simultaneously with wave

and wind forces. For locations near channels such as Kap Shui Mun, Urmston Road, Tolo Channel, Rambler Channel and Lei Yue Mun, where above average currents are encountered, the figure of 1 m/s should not be used without a detailed investigation. Where measurements or mathematical modelling results are available, the designer should assess design current velocities for the various loading conditions.

The direction of the design current for locations where no information or records are available should be determined by the designer. For locations close to the shore, the direction may normally be assumed to be parallel to the shoreline. For isolated locations remote from the shore, it should normally be assumed that the design current can occur in all directions.

For the assessment of current forces on piles and other parts of structures, for all loading conditions other than for temporary conditions during construction, the area normal to flow should include an allowance for marine growth. Where no other information or site measurements are available, a uniform effective thickness of 100 mm of marine growth for all surfaces below mean sea level may be assumed.

5.11.2 Steady Drag Forces

Loads imposed by currents on marine structures may be classified as either drag forces parallel to the flow direction, or cross-flow forces transverse to the flow direction. Current drag forces are principally steady; the oscillatory component is only significant when its frequency approaches the natural frequency of the structure. Cross-flow forces are entirely oscillatory for bodies symmetrically presented to the flow. Steady drag forces on a circular pile in a uniform current may be calculated using the formula given as follows :

$$f_D = \frac{1}{2} C_D \rho v^2 D$$

where f_D : Drag force per unit length.

C_D : Drag coefficient.

ρ : Density of water.

v : Velocity of current normal to pile axis.

D : Pile diameter (including marine growth).

Where the current is not uniform over the water column, the total drag force can be determined by adding the drag force at different depths of the pile. The drag coefficients for circular cylinders is given in Figure 19.

5.11.3 Flow-induced Oscillations

A pile in a current experiences fluctuating forces, both in-line and cross-flow, due to the shedding of vortices downstream of the pile. The frequencies of the fluctuating forces are directly related to the frequency of the vortex shedding and the amplitude of the fluctuating force increases as its frequency approaches the natural frequency of the pile or of the structure as a whole.

Piled structures are particularly vulnerable to this type of oscillation during construction. Hence, restraint should be provided to pile heads immediately after driving to prevent the possibility of oscillation in the cantilever mode. For completed structures in typical water depths and with the types of pile normally used in Hong Kong, it is not usually necessary to check critical flow velocities causing the oscillations. However, for structures in particularly deep water where slender piles are being considered and at locations where high design current velocities are encountered, reference should be made to BS 6349:Part 1 (BSI, 2000) to check whether flow-induced oscillations will occur.

5.12 Berthing Loads

5.12.1 General

In the course of berthing, loads will be generated between the vessel and the berthing structure from the moment at which contact is first made until the vessel is finally brought to rest. The magnitude of the loads will depend, not only on the size and velocity of the vessel, but also on the nature of the structure, including any fendering, and the degree of resilience it presents under impact.

Berthing loads transmitted to a structure comprise berthing reactions normal to the berthing face and friction loads parallel to the berthing face. The berthing reactions normal to the berthing face depends upon the berthing energy and the load/deflection characteristics of the vessel, structure and fender system, and should be determined in accordance with Section 5.12.2 and Section 5.12.3. The friction loads parallel to the berthing face may be taken as the coefficient of friction between the two faces in contact multiplied by the berthing reaction and should be considered in both the horizontal and vertical directions. Where necessary, reference on the coefficient of friction should be made to the manufacturers of the selected fender units.

5.12.2 Assessment of Berthing Energy

The total amount of energy E (kNm) to be absorbed, either by the fender system alone or by a combination of the fender system and the structure itself with some flexibility, may be calculated from the following energy formulae :

$$E = \frac{1}{2} * C_m * M_v * V_b^2 * C_e * C_s * C_c$$

where C_m is the hydrodynamic coefficient.

M_v is the displacement of the vessel (t).

V_b is the velocity of the vessel normal to the berth (m/s).

C_e is the eccentricity coefficient.

C_s is the softness coefficient.

C_c is the berth configuration coefficient.

This energy depends on the velocity of the vessel normal to the berth and a number of factors that modify the vessel's kinetic energy to be absorbed by the fender system and the structure.

(1) Berthing Velocity

The berthing velocity of the vessel normal to the berth depends on the vessel size and type, frequency of arrival, possible constraints on movement approaching the berth, and wave, current and wind conditions likely to be encountered at berthing. Where no other information is available, for the normal loading conditions referred to in Section 5.2, the following berthing velocities normal to the berth may be used as a guide :

<i>Vessel Displacement</i> (t)	<i>Berthing Velocity Normal to Berth</i> (m/s)
Under 100	0.40
100 to 200	0.35
200 to 2,000	0.30
2,000 to 10,000	0.20

The berthing velocities normal to the berth suggested above relate to structures located at sites with normal exposure to environmental conditions without excessive frequency of use, and assume that berthing may continue after the raising of Tropical Cyclone Signal No. 3, and for the first few hours after the raising of Tropical Cyclone Signal No. 8. Before any velocity is finally adopted for detailed design, advice should be sought from the clients, users or ferry

operators as appropriate.

For Accident Loading Conditions, general comments are given in Section 5.2.4. The vessel displacement and berthing velocity for such conditions should be decided by the designer for the individual structure being considered, but as a general rule the total energy to be absorbed for accident loading should be at least 50% greater than for normal loading. For particularly critical structures or for structures with expected heavy use and unfavourable exposure, this may need to be increased to 100%.

Where adequate statistical data on berthing velocities for vessels and conditions similar to those of the berth being designed are available, the velocity should be derived from these data in preference to the above suggested values.

(2) Hydrodynamic Mass Coefficient

The hydrodynamic mass coefficient allows the movement of water around the ship to be taken into account when calculating the total energy of the vessel by increasing the mass of the system. The hydrodynamic mass coefficient C_m may be calculated from the following equation (BSI, 2014) :

$$C_m = 1 + 2 * \frac{D_v}{B_v}$$

where D_v is the draft of the vessel (m).
 B_v is the beam of the vessel (m).

(3) Eccentricity coefficient

A vessel will usually berth at a certain angle and hence it turns simultaneously at the time of first impact. During this process, some of the kinetic energy of the ship is converted to turning energy and the remaining energy is transferred to the berth. The eccentricity coefficient represents the proportion of the remaining energy to the kinetic energy of the vessel at berthing (see Figure 20). The formula for calculating the coefficient is given as follows (BSI, 2014):

$$C_e = \frac{(K_v^2 + R_v^2 \cos^2 \gamma)}{(K_v^2 + R_v^2)}$$

where K_v is the radius of gyration of the ship.

$$K_v = (0.19C_b + 0.11) L_v$$

L_v is the length of the hull between perpendiculars (m).

C_b is the block coefficient, typically in the range of 0.5 to 0.85.

$$C_b = \text{displacement (kg)} / (L_v(\text{m}) \times \text{beam}(\text{m}) \times \text{draft}(\text{m}) \times \text{density of water}(\text{kg/m}^3))$$

R_v is the distance of the point of contact from the centre of mass (m).

γ is the angle between the line joining the point of contact to the centre of mass and the velocity vector.

(4) Softness Coefficient

The softness coefficient allows for the portion of the impact energy that is absorbed by the vessel's hull. Generally, the energy absorbed by the deformation of the ship's hull is small. In the absence of more reliable information, the value of the softness coefficient should be taken as 1.0 (BSI, 2014).

(5) Berth Configuration Coefficient

The berth configuration coefficient allows for the portion of the vessel energy which is absorbed by the cushioning effect of the water trapped between the vessel hull and the structure. For solid quay walls or seawalls, the coefficient should be taken as between 0.8 and 1. For pile-supported deck structures, a value of 1.0 should be used (BSI, 2014).

(6) Energy Capacity of Fenders

The designed energy capacity of each fender should in general be at least 50% greater than that calculated for normal loading conditions to allow for accidental occurrences such as vessel engine failure, breaking of mooring or towing lines, sudden changes of wind or current conditions and human error. Because of the non-linear energy/deflection and reaction/deflection characteristics of most fender systems, the effects of both normal and abnormal impacts on the fender system and berth structures should be examined.

5.12.3 Berthing Reactions

Berthing reaction is a function of the berthing energy and the deformation characteristics of the fender system. After the berthing energy is calculated, berthing reaction to be taken by the structure can be assessed from the manufacturer's performance curves once the type of fender to be used has been determined. A performance curve shows the relationship of the

deflection, energy absorption and reaction of a fender.

Where the point of impact is not on the straight run of the vessel hull and the vessel is not parallel to the berth at impact, the fender unit will receive an angular loading. The hull geometry over the impact area should therefore be considered in both horizontal and vertical planes (see Figure 21) to establish the angle of application of load to individual units. Manufacturers of proprietary rubber fender units usually provide correction factors to the performance data of their units under angular berthing conditions.

5.13 Mooring Loads

Mooring loads comprise those loads imposed on a structure by a vessel tied up alongside, both through contact between the vessel and structure or its fender system, and through tension in mooring ropes. They also include loads arising from manoeuvres of the vessel at the berth but exclude the impact and frictional berthing loads. These loads are principally caused by winds, currents and, in more exposed locations, by waves.

Mooring bollard locations and normal maximum working loads should be agreed with the Director of Marine, user departments and the ferry operators as appropriate. For Normal Loading Conditions, mooring loads may be assumed to be equal to the normal maximum bollard working loads. As a general guidance, the following bollard loads may be assumed without specific calculation on the probable maximum mooring loads :

<i>Vessel Displacement</i> (t)	<i>Bollard Loading</i> (kN)
Up to 2,000	100
Up to 10,000	300

Where it is considered necessary to calculate the forces acting on the moored vessels in order to check bollard loads or loads imposed directly by vessels on a structure, reference may be made to BS 6349:Part 1 (BSI, 2000) and Part 4 (BSI, 2014) for further details.

At exposed locations, where wave loading is severe, the dynamic response of the vessel under restraint of mooring lines and fenders should be determined by model testing, mathematical analysis or other methods with reference to the guidance given in Clause 31 of BS 6349:Part 1 (BSI, 2000).

In the design calculations of the marine structures, allowance should be made for the mooring

lines not being horizontal. If no other information is available, a maximum angle to the horizontal of 30° (up and down) may be assumed. The direction of each mooring load should be taken as that having the most adverse effect on the structure, and in general it should be assumed that all mooring loads on a structure can act simultaneously.

5.14 Temperature Variation

The loads or load effects arising from thermal expansion or contraction of the structure and from temperature gradients in the structure will usually be minor in relation to other loads for marine structures with a maximum length between joints of 50 m, and need not be considered.

The loads arising from thermal expansion or contraction of the structure for marine structures with a length between joints exceeding 50 m should be assessed. This is particularly important for piers and similar pile-supported deck structures where thermal movements of the deck induce loads in the supporting piles. Where no specific information is available concerning the temperatures of the structure at the time of construction, and the extremes expected during the design life of the structure, for design purposes an effective maximum temperature drop of 25°C and an effective maximum temperature rise of 20°C can be assumed for relatively simple concrete deck structures under extreme environmental conditions. Under normal loading conditions, the effects of temperature variations may be ignored.

5.15 Earthquakes, Movements and Vibrations

For the marine structures covered by this Manual, seismic forces in Hong Kong may be assumed to be minor in relation to the combined effects of other imposed loads. Further information on seismicity may be obtained from GCO(1991), GEO(1992) and GEO(1997).

For guidance on movements and vibrations, reference may be made to Section 47 of BS 6349:Part 1 (BSI, 2000). For the marine structures covered by this Manual and the relatively shallow water depths normally applying, movement and vibration problems should not be expected and usually can be effectively ignored. Movements between different parts of structures, and between new and existing structures, should be assessed in the usual way in order to fix joint sizes and locations. Where vessel berthing occurs, movements of flexible and even relatively inflexible structures can be important in assisting with energy absorption.

6. CONSTRUCTION MATERIALS AND DURABILITY

6.1 General

This Chapter gives comments and guidance on particular matters related to material selection, use and specification. The materials covered are concrete, steel, timber, rubber, armour rock and fill materials. For general information on these materials and any other materials used in marine structures, reference should be made to the General Specification for Civil Engineering Works (GS) (HKSARG, 2020). Comments on aspects related to durability are also given in this Chapter.

6.2 Reinforced Concrete

Reinforced concrete structures should be designed to BS EN 1992. Since the design equations in EC and UK NA are made use of the characteristic cylinder strength (f_{ck}), the designer may make reference to Table 3.1 of BS EN 1992-1-1:2004 (BSI, 2004a) for conversion from the characteristic cube strength ($f_{ck,cube}$) which is being used in the GS to the characteristic cylinder strength when carrying out the design. Recommended design parameters for concrete and steel reinforcement given in Table 41 should be adopted in design of marine structures. The partial factors for materials given in Clause 2.4.2.4 of BS EN 1992-1-1:2004 (BSI, 2004a) should also be adopted.

The durability of reinforced concrete depends fundamentally on the quality of the concrete and the cover to the reinforcement embedded inside the concrete. Normally, the alkalinity of the concrete enables the formation of a protective passivity layer around the reinforcement that prevents corrosion. However, under intermittent or periodical wetting and drying conditions, chloride of seawater that penetrates into the concrete will break down the passivity layer and initiate corrosion of the reinforcement. Therefore, it is important to use a concrete mix with high density and the required workability for adequate compaction and to provide a large concrete cover to the reinforcement bars to delay the time for ingress of chloride to the reinforcement. The specification given in Appendix 21.2 of Section 21 of GS (HKSARG, 2020) for reinforced concrete in marine environment should be adopted for design of marine structures.

The specification also stipulates other requirements on cements, aggregates, chemical admixtures, pulverised fuel ash or blast furnace slag and curing compounds to ensure that :

- Suitable constituents and mix compositions are used.
- Concrete mixes are sufficiently workable to ensure effective compaction.
- Harmful chemical reactions in the concrete are within acceptable levels.
- Adequate curing is carried out in order to achieve the desired durability.

6.3 Unreinforced Concrete

For unreinforced concrete in massive sections, such as precast concrete seawall blocks and backing concrete for granite facing in seawalls, the use of concrete with a minimum characteristic strength of 20 MPa has been shown to be successful with no significant maintenance problems. The continued use of such concrete for massive sections is recommended, irrespective of whether the concrete is fully immersed or within the tidal or splash zones, provided the concrete is actually cast in the dry.

Partial replacement of cement by pulverized fuel ash in thick sections will reduce effects of heat of hydration. Replacement of up to 50% of the cement may be considered if early strength is not critical.

6.4 Underwater Concrete

Guidance on underwater concrete is given in Section 58.4.12 of BS 6349:Part 1 (BSI, 2000). Reinforced concrete placed underwater should only be used where absolutely necessary, because of the difficulties of ensuring sound results and the problems of inspection. In particular, the use of concrete placed by tremie for forming heavily reinforced elements such as pile caps within the fully immersed or tidal zones should be avoided, and the use of precast units or the use of watertight steel shutters, extended in height as necessary to avoid being flooded by seawater due to tide level change or wave action, should be adopted to enable the concrete to be cast in dry condition.

It should be noted that concrete placed under water should not be designed for a characteristic strength greater than 25 MPa. It is recommended that this limitation should apply to bored piles formed by reinforced concrete placed by tremie due to the defects which can occur, but a higher grade of concrete should be specified in order to achieve this condition.

6.5 Steel

6.5.1 Structural Steel in General

Structural steel in marine structures should normally be weldable structural steel complying with BS EN 10025 (BSI, 1993) for structural sections, BS EN 10248 (BSI, 1996a & b) for hot rolled sheet piling, BS EN 10210 (BSI, 1994 & 1997d) for tubular piles made of hot formed sections, and BS EN 10219 (BSI, 1997a & b) for tubular piles made of cold formed sections as appropriate.

6.5.2 Corrosion Protection

In the design of steel structures and steel elements, corrosion protection, allowance for metal losses due to corrosion or both are major considerations. It should be noted that the advice in Table 25 of BS 6349:Part 1 (BSI, 2000), which gives typical upper rates of corrosion for structural steels in maritime conditions for temperate climates, is not recommended for use in Hong Kong. Hong Kong waters are relatively warm, and contain various pollutants whose effect on steel is generally unknown. In many sites, the presence of anaerobic sulphate-reducing bacteria, which can greatly increase normal steel corrosion rates, is also suspected. In the absence of full scale long-term tests covering metal loss from corrosion in Hong Kong waters, it is recommended that all structural steelwork above sea-bed level, whether fully immersed, within the tidal or splash zones, or generally above the splash zone, is fully protected against corrosion for the design life of the structure. Below sea-bed level, an allowance for corrosion loss of 0.05 mm per year on the outside face of steel is considered reasonable if no corrosion protection is carried out within this zone. For guidance on protective measures which can be taken against corrosion, Section 6.8 should be referred to.

6.5.3 Use of Stainless Steel

Section 21 of the GS requires stainless steel for elements in marine works such as chains, railings, cat ladders, pumphouse screens and screen guides, mooring eyes and other fittings to be austenitic stainless steel grade 316 complying with BS 970:Part 1 (BSI, 1996c), BS 1449:Part 2 (BSI, 1983), or BS EN 10088 (BSI, 1995a, b & c) as appropriate. It should be noted that the commonly available grade 304 stainless steel is not suitable for use in a marine environment due to the presence of chlorides. The selection of the correct grade of stainless steel at the design stage is most important, as corrosion in stainless steel members and fasteners may not be readily evident. In stress corrosion cracking, corrosion occurs along grain boundaries, and there may be no corrosion product evident, or only slight staining.

A visual examination may not show this cracking, even though the member or fastener is about to fail.

6.5.4 General Guidance

General guidance on the use of structural steel and other metals in marine structures is given in Clause 59 of BS 6349:Part 1 (BSI, 2000). Important points to note are as follows :

- Fabrication details should be kept as simple as possible and should be designed to avoid corrosion and facilitate maintenance.
- Tolerances for on-site connections should be generous because of the difficulties associated with working in a marine environment.
- As much prefabrication as possible should be undertaken, taking advantage of mechanised welding and early painting under factory-controlled conditions.
- Steel embedded in concrete is cathodic relative to the same steel in seawater, and rapid corrosion will therefore occur at the interface of a partly embedded member unless special treatment is carried out, e.g. use of sacrificial anodes or impressed currents.
- Chemical composition of steels has less influence on corrosion rates in a marine environment than physical factors such as the roughness of the surface finish of the steel and the presence of holes and re-entrant corners, all of which tend to promote the formation of galvanic corrosion cells.

6.6 Timber

Timbers are mainly used in the fendering system of marine structures in Hong Kong in the past. However, such application is considered not environmentally friendly and hence further use of timber as fenders is not recommended. Where the use of timbers in marine structure are considered necessary, reference should be made to BS 5756 (BSI, 1997c) and [BS EN 1995-1-1:2004+A2:2014 \(BSI, 2004b\)](#).

6.7 Rubber

Section 21 of the GS requires rubber for fenders to be resistant to aging, weathering and wearing, to be homogeneous, free from any defects or impurities, pores or cracks and to have certain defined properties as covered by parts of BS 903 (BSI, several parts, 1990 to 1998). Types of rubber fenders available in the market can be obtained from manufacturer's catalogues. Information given in major manufacturers' catalogues concerning fender reaction, deformation and energy characteristics may generally be accepted with confidence. Before finalising a rubber fender design, advice should always be sought from one or more of the major reputable suppliers regarding suitability for the project. Wherever possible, rubber fenders should be selected or specified to match existing fenders, to minimise the different types of fenders required to be kept in stock for future maintenance.

6.8 Protective Measures

6.8.1 General

Information on protective measures which can be used to stop or reduce deterioration in marine structures is given in Section 66 of BS 6349:Part 1 (BSI, 2000). Comments on corrosion losses for steel in local conditions are given in Section 6.5.2

6.8.2 Protective Coatings for Steel

BS EN ISO 12944 (8 parts, 1998) gives guidance on the choice, design and specification of coating systems available, although it should be noted that the definitions of environment and recommendations for coatings may not be straightly applicable to local conditions which are likely to be more corrosive, due mainly to higher air and sea temperatures and humidity. For the use of coating materials under local conditions, the advice of the manufacturers should be sought and followed.

The period during which the protection covered by paint systems is effective is generally shorter than the design life of the structure. Due consideration should be given at the planning and design stage to the possibility of their maintenance and renewal. As a general guidance, structural components which are exposed to corrosion stresses and which are no longer accessible for corrosion protection measures after assembly should be provided with corrosion protection that will remain effective for the duration of the design life of the structure. If this cannot be achieved by means of protective coating systems, other measures,

such as manufacturing components from corrosion-resistant material, designing components so that they are replaceable, or the specification of a corrosion allowance, should be considered.

The cost-effectiveness of a given corrosion protection system is generally in direct proportion to the length of time for which effective protection is maintained, and the amount of maintenance or replacement work required during the design life of the structure should be reduced to a minimum. Durability has been indicated in BS EN ISO 12944 in terms of three ranges. These include low durability: 2 to 5 years, medium durability: 5 to 15 years, and high durability: more than 15 years. The life requirement of the protective coating should be based on the time which can elapse before major or general maintenance of the coating becomes necessary, and should be agreed by the interested parties. Such life requirement can assist the client or the maintenance authority to set up a maintenance programme. General information on the expected durability of various types of coatings can be found in BS EN ISO 12944.

6.8.3 Protective Coatings for Concrete

Coatings may be used to provide additional corrosion protection to marine concrete structures by preventing ingress of external deleterious agents such as chloride into the concrete. The coatings applied to such concrete should normally be resistant to abrasion, salt sprays and salt water immersion. The life of a coating system prior to the need of re-coating should be at least ten years and should have bridging resistance over cracks due to flexural loading.

Some types of concrete coatings for local marine conditions are given in the Model Specification for Protective Coatings for Concrete published by the Civil Engineering Department (CED, 1994). Generally, suitable coating systems applied in the splash zone include acrylic and polyurethane, but epoxy and coal tar epoxy may also be used if protected from sunlight. Silane could also be used at limited locations in splash zone where concrete is not wholly saturated. For the tidal zone, coating systems such as cross-linking high performance epoxy, coal tar epoxy and polyurethane are normally effective for immersed conditions.

The Model Specification also provides guidance on the choice, application, specification, testing methods and acceptance criteria of protective coatings for concrete of marine structures. Reference should be made to it for further details. Designers are also advised to seek for the latest information on coatings.

6.8.4 Cathodic Protection for Reinforced Concrete

Cathodic protection may be applied to restrain reinforcement corrosion in marine concrete structures by causing direct current to flow from the electrolytic environment into the reinforcement. There are generally two systems of cathodic protection, namely, the impressed current system and the sacrificial anode system. The impressed current system operates by passing an external direct current through a permanent anode fixed in the concrete to the reinforcement. The use of this system requires a permanent power supply at the structures. An alternate cathodic protection system is called sacrificial anode system in which the reinforcement is connected to a sacrificial anode without using a power supply. Metals that can be used as sacrificial anodes include zinc, aluminum and magnesium. Nowadays, alloys of these metals are normally used as sacrificial anodes. As sacrificial anodes need to be replaced every several years, they should be fixed at locations that are relatively easy for future inspection and replacement.

The design of a cathodic protection system requires specialist knowledge and experience and should be undertaken by a suitably qualified corrosion expert.

A pre-requisite requirement for the installation of cathodic protection system is to ensure that the embedded reinforcement is electrically connected. This should be checked carefully during the construction stage by electrical continuity measurement over the reinforcing bars or steel elements. Any discontinuity should be rectified immediately.

6.8.5 Corrosion Protection of Steel Tubular Piles

For the corrosion protection of steel tubular piles, covering the immersed, tidal and splash zones, the use of polyethylene sheeting for coating steel tubular piles may be considered, and in theory such a system should be able to offer full corrosion protection for the piles. The polyethylene sheeting is normally several millimetres thick and is applied under controlled factory conditions by heat-shrinking on the outside surface of the steel tube, which has been treated with undercoat/primer and an adhesive layer. However, this type of coating can be damaged during handling and driving, or by vessel activities during operation stage of the structure. Therefore, the condition of the coating should be thoroughly checked after construction and frequently inspected during the operation stage.

The other corrosion protection method is to apply a spiral wrap of denso tape around the steel piles. The system normally consists of an inner anti-corrosion tape wrapping with an outer armouring layer. It seals out oxygen and water and forms an anti-corrosion barrier by

displacing water and forming a moisture resistant bond. A tough outer cover surrounds this component to protect against weathering and mechanical damage. This system can be applied below and above water on site without heat-shrinking, and is suitable for the repair of existing piles.

For all proprietary coatings and wrappings, where site application is unavoidable, the advice of the manufacturer, particularly with regard to surface preparation, should be strictly followed and close supervision maintained.

The electrochemical processes leading to corrosion of submerged steel elements in seawater are described in BS 7361 (BSI, 1991), which also gives details of the way that cathodic protection should be applied to combat corrosion. Cathodic protection avoids the problems usually encountered in the use of coating or wrapping systems due to damage by handling, driving or vessel operations, but this system is generally considered to be only effective up to about half-tide mark. It is recommended that the detailed design for any cathodic protection system should be entrusted to a suitably qualified specialist company and an operating and maintenance manual should be provided. For monitoring work after installation, consideration should be given to arranging a maintenance contract with a suitably qualified specialist.

To reduce the possibility of long term maintenance problems, consideration may be made for steel tubular piles to be infilled with reinforced concrete to a depth below seabed level at least adequate for loading transfer between the concrete and the steel tube, and the steel tube above seabed level can be considered as sacrificial and ignored for design purposes. The length of pile above seabed level in effect becomes a reinforced concrete cast in-situ pile. Such reinforced concrete should follow the recommendations of Section 6.2, with the increase in durability provided by the steel 'casing' as an additional benefit, and should be cast in a dry condition. For the latter, it is usually possible, after excavation, to form a plug in the bottom and pump the inside of the pile dry before concreting.

6.8.6 Corrosion Monitoring

To monitor the conditions of the structures, it is recommended that corrosion monitoring devices should be installed to provide the necessary information for the maintenance engineers to take actions against corrosion. The design of such corrosion monitoring system by a qualified specialist is required. It should be noted that, no matter how sophisticated the corrosion monitoring system is, visual inspection is still required and should be incorporated in any corrosion monitoring program.

6.8.7 Important Points to be Considered

The following notes, which are summarized from Clause 66.1 of BS 6349:Part 1 (BSI, 2000), are particularly important when considering protective systems :

- Potential corrosion hazards can be eliminated by planned maintenance and monitoring of the structure or by increasing the allowance of the structural strength.
- The costs of protective measures are repetitive in that the protective materials themselves deteriorate, and regular maintenance and renewal of coatings will be necessary for all structures except those with relatively short design lives.
- For important, heavily used structures, regular maintenance and renewal of coatings should be designed to allow normal use of the structures.
- Corrosion does not proceed at a uniform rate over the whole structure or member, and at certain corrosion points, loss of the original material can be much more rapid than expected; any estimate of a corrosion allowance is likely to be excessive for some parts while being inadequate for others.
- The cost of renewing a protective system is likely to be much more than the initial protection due to the need to remove marine growth and old paint prior to renewal of the system, and the fact that access will usually be more difficult than during construction.
- Marine growth is prevalent on structures below mean high water level. Evidence exists that such growth can be protective against corrosion and therefore generally should not be removed, as it may be more effective and durable than a paint system which might replace it. Normally the only exposure zones which might usefully be repainted are the splash and atmospheric zones.

6.9 Armour Rock

The properties of armour rock should comply with the requirements given in Section 21 of the GS. For armour design, it is recommended that the specific gravity of the rock, if obtained

locally, should be taken as 2.6. This figure corresponds to the minimum requirement of specific gravity given in Section 21 of the GS. A value higher than 2.6 should not be used for design without extensive testing, both prior to construction, where a rock source has been identified, and during construction for quality control.

The normal maximum armour size available locally in reasonable quantities is generally in the range of 6 to 8 t, although sizes up to about 10 t may be available in small quantities. Where required maximum rock armour sizes exceed the range given above, the use of precast concrete armour units will normally be necessary, taking into account the effect on cost and programming of the project.

6.10 Fill

General requirements of the different types of fill material for marine works, including their particle size distribution, are given in Section 21 of the GS. Reference should also be made to the guidance notes for the GS (HKSARG, 2020) providing further information on the fill material, which is summarized in the following paragraphs :

- Underwater fill material (Type 1) shall consist of natural material extracted from the seabed or a river bed, and is basically natural sand similar to coarse sand free from deleterious material.
- Underwater fill material (Type 2) shall consist of material which has a coefficient of uniformity exceeding 5 and a plasticity index not exceeding 12. It is basically decomposed granite or similar type of rock. The restriction on plasticity index is intended to limit the clay content of the material.
- Rock fill material (Grade 75) shall consist of pieces of hard, durable rock which are free from cracks, veins, discolouration and other evidence of decomposition. It is usually used as levelling founding layers for marine structures. The maximum rock size is 75 mm (for BS test sieve size).
- Rock fill material (Grade 700) shall consist of pieces of rock which are free from cracks, veins and similar defects, and not more than 30% by mass shall be discoloured or show other evidence of decomposition. The maximum rock size is 700 mm (for BS test sieve size).

Where decomposed granite is used for underwater foundations, reference can be made to the GEO report entitled “An Evaluation of the Suitability of Decomposed Granite as Foundation Backfill for Gravity Seawalls in Hong Kong” (GEO, 1993b). The suitability of the use of decomposed granite depends on many factors, such as grading, plasticity index, permeability, coefficient of consolidation and construction programme. In order to limit excess pore pressures within the construction period for maintaining the stability of the seawall, the deposited layer should normally not exceed 15 m thick and should not contain Grade VI materials as defined in Table 4 of *Geoguide 3* (GEO, 2017b). The suitability of decomposed rock other than granite is subject to designer’s evaluation.

General parameters of the above fill materials that may be adopted for design purpose are indicated as follows :

	<i>Bulk Density</i> (kN/m ³)	<i>Friction Angle</i> (degree)	<i>Cohesion</i> (kN/m ²)
Underwater fill (Type 1 and Type 2)	19	30	0
Rock fill material (Grade 700)	20	45	0

Values of fill parameters higher than those given above may be used for design when supported by evidence such as testing results of the fill material from an identified source both prior to and during construction.

Public fill is the inert portion of construction and demolition materials and can be used as fill material for reclamation through the provision and operation of public filling facilities. The requirements of the public fill are given by the conditions of the dumping licence issued under Section 5 of the Land (Miscellaneous Provisions) Ordinance (Cap.28) and are restricted to earth, building debris, broken rock and concrete. The materials shall be free from marine mud, household refuse, plastic, metal, industrial and chemical waste, animal and vegetable matter, and other material considered unsuitable by the filling supervisor. Small quantities of timber mixed with otherwise suitable material will be permitted. Since rock and concrete over 250 mm would impede subsequent piling works, they should be broken down below this size or deposited in areas where no building development will take place.

The Public Fill Committee (PFC) and Marine Fill Committee (MFC), under the Chairmanship of the Director of Civil Engineering, are responsible for the management of the use of fill materials for government, quasi-government and major private projects. The PFC is

responsible for overall management and coordination of the use of public fill and the provision and operation of public filling, and is also responsible for forecasting the generation of construction and demolition material and identifying the fill demands for reclamation and site formation projects. The MFC has the responsibility to identify and manage the supply and demand of marine fill resources in Hong Kong. The PFC and MFC should be consulted for the use of fill materials as appropriate during the planning of marine works projects.

It should be noted that when placing fill under water, the material and method of placement should be capable of achieving a relatively high density fill untreated, as external compaction is expensive. Care must be taken with the choice of bedding and filter materials to prevent loss of material from wave or current action and groundwater movements. Fill material placed immediately behind seawalls should be free draining to avoid the unnecessary build up of water pressures due to tidal lag and ground water flow.

7. MAINTENANCE CONSIDERATIONS

7.1 General

This chapter outlines the general principles that should be considered with respect to maintenance in the design of a marine structure.

7.2 Design Considerations

Marine structures require regular inspection and maintenance in the course of their life to ensure satisfactory long-term performance of the structures. Without proper maintenance, the life of a structure may be significantly reduced due to the corrosive marine environment and wear and tear of daily operation. This may lead to the need for serious remedial works or even replacement of the structure within an unexpectedly short time. Hence, it is necessary to take into consideration future maintenance aspects during the design stage.

Proper choice and specification of materials are important to ensure the durability of marine structures as this will affect the required maintenance effort in the future. In this connection, reference can be made to the guidance on the choice and specification given in Chapter 6 of this Part of the Manual. Use of protective coatings or cathodic protection and implementation of corrosion monitoring measures may also be considered to protect the reinforcement or steel from corrosion. These aspects should be considered collectively in the design stage with respect to the particular site and operational conditions in order to optimize the maintenance effort in the future.

Careful detailing of the structure will also have a beneficial effect on future maintenance. Some suggestions are provided as follows :

- Layouts or shapes of elements that will be subject to frequent usage or wear and tear should be detailed in such a way to minimize damage and to avoid malpractice of operations.
- Simple structural forms and precast or prefabricated units with the minimum of in-situ connections should be adopted wherever possible, as quality control of in-situ works in the tidal zone is generally more difficult.
- Attention should be paid to detailing to avoid congested reinforcement so that the concrete can be easily placed and subsequently compacted.
- For pier fenders which is frequently subject to the berthing loads of vessels,

extra members may be added on the fender framework to help redistribution of the berthing load and to provide additional fixing for the fender units.

7.3 Maintenance Facilities

Consideration should be given to the provision of facilities to facilitate inspection and maintenance. These facilities should include access holes, ladders, fixing or lifting hooks, access walkways, guard rails, inspection openings and associated safety measures as appropriate. The design of these maintenance facilities should take into account the appearance and functions of the structure and advice should be sought from the maintenance authority before finalizing these details. Specific requirements on maintenance facilities for piers, dolphins, seawalls and breakwaters will be given in the following parts of the Manual :

- Part 2 : Guide to Design of Piers and Dolphins
- Part 4 : Guide to Design of Seawalls and Breakwaters

7.4 Design Memorandum and Maintenance Manual

On completion of the design, the designer should provide the design memorandum containing all the information relevant to the marine works or structures. This should be updated at the end of construction if necessary to include any as-constructed modifications to the original design. Such information should form the basis for the maintenance records and, together with the as-constructed drawings, should be passed to the maintenance authority. Where considered appropriate by the maintenance authority, a maintenance manual, on completion of the design, should be submitted to the maintenance authority to recommend the maintenance work required. The maintenance manual should also be updated as necessary at the end of construction before handing over the works or structures. As a general guidance, a maintenance manual should be prepared for the maintenance authority under the following circumstances :

- Large scale marine works or structures that will require significant input of maintenance resources.
- Marine works or structures with the use of non-routine design, facilities or materials.
- Marine works or structures requiring special inspection, monitoring or maintenance techniques.

The maintenance manual should contain a description of the maintenance objectives, an inspection programme, the likely failure modes, monitoring requirements, criteria for maintenance actions and recommended maintenance work or procedures. Any items which require specialist input and use of special maintenance equipment or monitoring devices should be identified and brought to the attention of the maintenance authority. The maintenance manual should be prepared by the designer in consultation with the maintenance authority.

8. AESTHETICS

8.1 General

Marine structures can be very dominant features in the harbour, seafront and adjacent landscape and their appearance may have a significant impact on the visual quality of the surroundings. Therefore, good appearance is an important element in design, and consideration should commence in the preliminary design stage as it will have a significant bearing on subsequent design process.

8.2 Principles

Various aspects of a marine structure would affect public perception of whether it is aesthetically pleasing. Examples of these include the form, dimensional proportion, colour, quality of materials and surface textures. Since the introduction of a structure will invariably modify the setting of a local environment, good appearance should also aim at fitting the structure with the surroundings. A structure with a harmonising appearance with the surroundings means that there should be no discordant features and the structure's attributes such as form, texture and colour should blend in a positive way with the corresponding characteristics of the surroundings. Attention should also be paid to the relationship of the structure with adjacent buildings, landscape features, seafront characteristics and scenic elements in order to achieve successful integration with the environment.

To fully appreciate the appearance of a marine structure, a designer should make use of visual aids including drawings, computer graphics, models and photo-montages to assist in the three-dimensional perception of the layout of the structure throughout the design process. Alternative forms of the structure should be compared in order to determine an aesthetically pleasing solution. In addition, careful design of the form and detailing of the structure together with sound appreciation of the site characteristics could make considerable improvement to the appearance without leading to significant increase in cost. Where appropriate, the advice of architect(s) or landscape architect(s) should be sought.

The sustainability of the appearance in the long term is also important to ensure that the structures remain attractive throughout its design life. In this connection, the following points should be noted :

- Use of durable materials or protective coatings which will not deteriorate significantly with time.
- Less durable materials, if used, should be confined to components which can be readily replaced.
- Careful detailing to reduce chance of damage or spoiling of surfaces or components due to accident or improper use, and to avoid easy trap of refuse and floating debris.
- Proper provision of facilities in the structure for cleaning and maintenance.
- Close supervision to avoid improper construction practices that may affect the durability of the structure.
- Systematic inspection and repair programme to maintain the structures in good condition.

REFERENCES

- Aas, GI, et al. (1986). Use of In-situ Tests For Foundation Design on Clay. 14th Specialty Conferences on the Use of In-situ tests in Geotechnical Engineering. Proc. of Soil Mechanics and Foundation Division, ASCE, pp 1-30.
- BD (2019). Code of Practice on Wind Effects in Hong Kong 2019. Buildings Department, Hong Kong.
- BD (2020). Code of Practice for Structural Use of Concrete 2013 (2020 Edition). Buildings Department, Hong Kong.
- Bjerrum, L. (1972). Embankments on soft ground. Proc. ASCE Specialty Conference on Earth and Earth-Supported Structures, Purdue University, Vol. 2.
- BSI (1983). Steel Plate, Sheet and Strip. Part 2 – Specification for Stainless and Heat-resisting Steel Plates, Sheets and Strip (BS 1449 Part 2:1983). British Standards Institution, London, 16p.
- BSI (several parts, 1990 to 1998). Physical Testing of Rubber (BS 903). British Standards Institution, London.
- BSI (1991). Cathodic Protection. Part 1 – Code of Practice for Land and Marine Applications (BS 7361 Part 1:1991). British Standards Institution, London, 116p.
- BSI (1993). Hot Rolled Products of Non Alloy Structural Steels. Technical Delivery Conditions (BS EN 10025:1993). British Standards Institution, London, 40p.
- BSI (1994a). Hot Finished Structural Hollow Sections of Non Alloy and Fine Grain Structural Steels. Technical Delivery Requirements (BS EN 10210-1:1994). British Standards Institution, London, 28p.

- BSI (1995a). Stainless Steels. Part 1 – List of Stainless Steels (BS EN 10088-1:1995). British Standards Institution, London, 24p.
- BSI (1995b). Stainless Steels. Part 2 – Technical Delivery Conditions for Steel Plates and Strip for General Purposes (BS EN 10088-2:1995). British Standards Institution, London, 48p.
- BSI (1995c). Stainless Steels. Part 3 – Technical Delivery Conditions for Semi-finished Products, Bars, Rods and sections for General Purposes (BS EN 10088-3:1995). British Standards Institution, London, 44p.
- BSI (1996a). Hot Rolled Sheet Piling of Non Alloy Steel. Technical Delivery Conditions (BS EN10248-1:1996). British Standards Institution, London, 16p.
- BSI (1996b). Hot Rolled Sheet Piling of Non Alloy Steel. Tolerances on Shape and Dimensions (BS EN10248-2:1996). British Standards Institution, London, 16p.
- BSI (1996c). Specification for Wrought Steels for Mechanical and Allied Engineering Purposes. Part 1 – General Inspection and Testing Procedures and Specific Requirements for Carbon, Carbon Manganese, Alloy and Stainless Steels (BS 970 Part 1:1996). British Standards Institution, London, 52p.
- BSI (1997a). Cold Formed Welded Structural Sections of Non Alloy and Fine Grain Steel. Technical Delivery Requirements (BS EN 10219-1:1997). British Standards Institution, London, 26p.
- BSI (1997b). Cold Formed Welded Structural Sections of Non Alloy and Fine Grain Steel. Tolerances, Dimensions, and Sectional Properties (BS EN 10219-2:1997). British Standards Institution, London, 34p.

- BSI (1997c). Specification for Visual Strength Grading of Hardwood (BS 5756:1997). British Standards Institution, London, 18p.
- BSI (1997d). Hot Finished Structural Hollow Sections of Non-alloy and Fine Grain Structural Steels. Tolerances, Dimensions, and Sectional Properties (BS EN 10210-2:1994). British Standards Institution, London, 30p.
- BSI (8 parts, 1998). Paints and Varnishes – Corrosion Protection of Steel Structures by Protective Paint Systems (BS EN ISO 12944-1 to 8:1998). British Standards Institution, London.
- BSI (2000). Maritime Structures – Part 1 : Code of Practice for General Criteria (BS 6349-1:2000). British Standards Institution, London, 189p.
- BSI (2004a). Eurocode 2: Design of Concrete Structures – Part 1-1: General Rules and Rules for Buildings (BS EN 1992-1-1:2004) and its respective UK National Annex. British Standards Institution, London.
- BSI (2004b). Eurocode 5: Design of Timber Structures – Part 1-1: General – Common Rules and Rules for Buildings (BS EN 1995-1-1:2004+A2:2014) and its respective UK National Annex. British Standards Institution, London.
- BSI (2014). Maritime Works – Part 4: Code of Practice for Design of Fendering and Mooring Systems (BS 6349-4:2014). British Standards Institution, London.
- CED (1994). Model Specification for Protective Coatings for Concrete. Civil Engineering Department, Hong Kong, 105p.
- Chen, T.Y. (1975). Comparison of Surface Winds in Hong Kong. Royal Observatory, Hong Kong, Technical Note No. 41, 43p.

- Chin & Leong (1978). Estimation of Wind Speeds near Sea-level during Tropical Cyclone Conditions in Hong Kong. Royal Observatory, Hong Kong, Technical Note No. 45, 31p.
- EAU (1990). Recommendations of the Committee for Waterfront Structures, Harbours and Waterways. The Committee for Waterfront Structures of the Society for Harbour Engineering and the German Society for Soil Mechanics and Foundation Engineering, Germany.
- GCO (1986 to 1990). Hong Kong Geological Survey Memoirs No. 1 to 3. Geology of Sha Tin, Hong Kong Island and Kowloon, and the Western New Territories. Geotechnical Engineering Office, Hong Kong, plus 1:20,000 scale maps.
- GCO (1991). Review of Earthquake Data for the Hong Kong Region (GCO Publication No. 1/91). Geotechnical Control Office, Hong Kong, 115p.
- GEO (1992). Earthquake Resistance of Buildings and Marine Reclamation Fills in Hong Kong (GEO Report No. 16). Geotechnical Engineering Office, Hong Kong, 55p.
- GEO (1992 to 1996). Hong Kong Geological Survey Sheet Reports No. 1 to 5. Geology of Yuen Long, Chek Lap Kok, Tsing Yi, North Lantau Island and Ma Wan, and Ma On Shan. Geotechnical Engineering Office, Hong Kong, plus 1:5,000 scale maps.
- GEO (1993b). An Evaluation of the Suitability of Decomposed Granite as Foundation Backfill for Gravity Seawalls in Hong Kong, GEO Report No. 33. Geotechnical Engineering Office, Hong Kong.
- GEO (1995 to 1996). Hong Kong Geological Survey Memoirs No. 4 to 6. Geology of the Northeastern New Territories, Lantau District, and Sai Kung and Clear Water Bay. Geotechnical Engineering Office, Hong Kong, plus 1:20,000 scale maps.

- GEO (1996). Conventional and CRS Rowe Cell Consolidation Test on Some Hong Kong Clays, GEO Report No. 55. Geotechnical Engineering Office, Hong Kong.
- GEO (1997). Pilot Study of Effects of Soil amplification of Seismic Ground Motions in Hong Kong (GEO Technical Note TN 5/97). Geotechnical Engineering Office, Hong Kong, 52p.
- GEO (2000a). The Pre-Quaternary Geology of Hong Kong. Hong Kong Geological Survey Memoir, Geotechnical Engineering Office, Hong Kong, 181p plus four 1:100,000 scale maps.
- GEO (2000b). The Quaternary Geology of Hong Kong. Hong Kong Geological Survey Memoir, Geotechnical Engineering Office, Hong Kong, 209p plus six 1:100,000 scale maps.
- GEO (2014). GEO Technical Guidance Note No. 41 (TGN 41) – Amendments to British Standards References in Technical Guidance Documents for Migration to Eurocodes. Geotechnical Engineering Office, Hong Kong.
- GEO (2017a). Guide to Site Investigation (Geoguide 2) (Continuously Updated E-Version released on 18 December 2017). Geotechnical Engineering Office, Civil Engineering and Development Department, HKSAR Government, 349 p.
- GEO (2017b). Guide to Rock and Soil Descriptions (Geoguide 3) (Continuously Updated E-Version released on 29 August 2017). Geotechnical Engineering Office, Civil Engineering and Development Department, HKSAR Government, 171 p.
- GEO (2017c). Model Specification for Soil Testing (Geospec 3c) (Continuously Updated E-Version released on 29 August 2017). Geotechnical Engineering Office, Civil Engineering and Development Department, HKSAR Government, 324 p.

- GEO (2022). Guide to Retaining Wall Design (Geoguide 1) (Continuously updated e-version released on 1 June 2020). Geotechnical Engineering Office, Civil Engineering and Development Department, HKSAR Government, 245 p.
- Head, K.H. (1985). Manual of Soil Laboratory Testing, Vol 3. Effective Stress Tests. John Wiley & Sons, Inc, New York, pp.1129-1225.
- HKHO (1997). HK Chart 1 – Symbols, Abbreviations, Terms used on Hong Kong Charts. Hydrographic Office, Marine Department, Hong Kong, 60p.
- HKPU (1995). Numerical Hindcast Study of Typhoon Generated Waves. The Hong Kong Polytechnic University.
- HKSARG (2020). General Specification for Civil Engineering Works, 2020 Edition. The Government of the Hong Kong Special Administrative Region, 2 volumes.
- HKU (1997). Study of Inner Harbour Waves and their Reduction – Final Report, 3 volumes. University of Hong Kong.
- HKU (1998). Study of Inner Harbour Waves and their Reduction – Wave Loading Determination for Wave Absorbing Seawalls. University of Hong Kong.
- HKPU (2000). Joint Probability Analysis of Extreme Sea Level and Wave Height – Final Report. The Hong Kong Polytechnic University.
- Ho, K.S. & Chan, Y.C. (1994). Ground Improvement Methods for Hong Kong Marine Mud. Geotechnical Seminar, Hong Kong Institution of Engineers, pp 85-102.
- Hogben, N., Dacunha, N. & Olliver, G. (1986). Global Wave Statistics. British Maritime Technology, 661p.

- Ladd, C.C., et al. (1977). Stress-Deformation and Strength Characteristics. State-of-art Report, 9th International Conference of Soil Mechanics and Foundation Engineering, Vol. 2, pp. 421-494.
- OCDI (2002). Japanese Technical Standards for Port and Harbour Facilities with Commentary (1999 Edition). Overseas Coastal Development Research Institute, Tokyo.
- PIANC and IAPH (1997). Approach Channels : A Guide for Design. Final Report of PTCII-30, Supplement to PIANC Bulletin, no. 95, 108p.
- Poon, W.C. (1982). Tropical Cyclones Causing Persistent Gales at the Royal Observatory 1884 – 1957 and at Waglan Island 1953 – 1980. Royal Observatory, Hong Kong, Technical Note No. 66, 33p.
- WB (2000). Works Bureau Technical Circular No. 22/2000 – Enhanced Quality Supervision and Assurance for Pile Foundation Works. Works Bureau, Hong Kong.

TABLES

LIST OF TABLES

Table No.		Page No.
1	Five-day Normals of the Meteorological Elements for Hong Kong (1981-2010)	111
2	Mean Sea Levels, Mean Higher High Water Levels and Mean Lower Low Water Levels	113
3	Extreme Sea Levels at Ko Lau Wan (1954-2019)	113
4	Extreme Sea Levels at Quarry Bay/North Point (1954-2019)	114
5	Extreme Sea Levels at Tai Po Kau (1962-2019)	114
6	Extreme Sea Levels at Tsim Bei Tsui (1954-2019)	114
7	Extreme Sea Levels at Waglan Island (1954-2019)	115
8	Extreme Sea Levels at Chi Ma Wan (1954-2019)	115
9	Extreme Sea Levels at Lok On Pai (1981-1999)	115
9A	Extreme Sea Levels at Tai O (1954-2019)	116
10	Observed Minimum Sea Levels	116
11	Probable Minimum Sea Levels at Quarry Bay/North Point (1954-Oct 2017)	116
12	Mean Hourly Wind Speeds (m/s) – Kai Tak Airport Southeast Station (1968-2020)	117
13	Mean Hourly Wind Speeds (m/s) – Cheung Chau Station (1953-2020)	117
14	Mean Hourly Wind Speeds (m/s) – Waglan Island Station (1953-2020)	117

Table No.		Page No.
14A	Mean Hourly Wind Speeds (m/s) – Hong Kong International Airport Station (1979-1983, 1997-2020)	118
15	Mean Wind Speeds East Direction (m/s) – Kai Tak Southeast Station (1968-2020)	118
16	Mean Wind Speeds Southeast Direction (m/s) – Kai Tak Southeast Station (1968-2020)	118
17	Mean Wind Speeds West Direction (m/s) – Kai Tak Southeast Station (1968-2020)	119
18	Mean Wind Speeds North Direction (m/s) – Cheung Chau Station (1953-2020)	119
19	Mean Wind Speeds Northeast Direction (m/s) – Cheung Chau Station (1953-2020)	119
20	Mean Wind Speeds East Direction (m/s) – Cheung Chau Station (1953-2020)	120
21	Mean Wind Speeds Southeast Direction (m/s) – Cheung Chau Station (1953-2020)	120
22	Mean Wind Speeds South Direction (m/s) – Cheung Chau Station (1953-2020)	120
23	Mean Wind Speeds Southwest Direction (m/s) – Cheung Chau Station (1953-2020)	121
24	Mean Wind Speeds North Direction (m/s) – Waglan Island Station (1953-2020)	121
25	Mean Wind Speeds Northeast Direction (m/s) – Waglan Island Station (1953-2020)	121
26	Mean Wind Speeds East Direction (m/s) – Waglan Island Station (1953-2020)	122
27	Mean Wind Speeds Southeast Direction (m/s) – Waglan Island Station (1953-2020)	122

Table No.		Page No.
28	Mean Wind Speeds South Direction (m/s) – Waglan Island Station (1953-2020)	122
29	Mean Wind Speeds Southwest Direction (m/s) – Waglan Island Station (1953-2020)	123
30	Mean Wind Speeds West Direction (m/s) – Waglan Island Station (1953-2020)	123
30A	Mean Wind Speeds North Direction (m/s) – Hong Kong International Airport Station (1979-1983, 1997-2020)	123
30B	Mean Wind Speeds Northeast Direction (m/s) – Hong Kong International Airport Station (1979-1983, 1997-2020)	124
30C	Mean Wind Speeds Southeast Direction (m/s) – Hong Kong International Airport Station (1979-1983, 1997-2020)	124
30D	Mean Wind Speeds Southwest Direction (m/s) – Hong Kong International Airport Station (1979-1983, 1997-2020)	124
30E	Mean Wind Speeds West Direction (m/s) – Hong Kong International Airport Station (1979-1983, 1997-2020)	125
30F	Mean Wind Speeds Northwest Direction (m/s) – Hong Kong International Airport Station (1979-1983, 1997-2020)	125
30G	Brief History of the Anemometers at the Four Wind Stations	126
31	Relationship of Higher Wave Heights with Significant Wave Height	126
32	Wave Measurement at Kau Yi Chau Station (1994-2020)	127
33	Wave Measurement at West Lamma Channel Station (1994-2020)	128
34	Offshore Wave Data from Storm Hindcasting	129

Table No.		Page No.
35	Effect of Waves on Harbour Activities	129
36	Basic Characteristics of Vessels – Local Craft Register (January 2000)	130
37	Basic Characteristics of Vessels (August 2000)	131
38	Geology of Offshore Sediments in Hong Kong	134
39	Engineering Properties of Hong Kong Marine Mud	134
40	Typical Soil Tests	135
41	Design Parameters for Concrete and Steel Reinforcement	136
42	Rise in Mean Sea Levels Due to Climate Change	136
43	Increase in Extreme Wind Speeds Due to Climate Change	137
44	Storm Surge Increase Due to Climate Change	137
45	Design Allowance to Enhance Climate Resilience	139
46	An Example of Increase in Design Extreme Sea Level Due to Climate Change Effect in Year 2100 for 1 in 100 year return period	140

Table 1 Five-day Normals of the Meteorological Elements for Hong Kong 1981 – 2010

	M.S.L. Pressure (hPa)	Air Temperature			Wet-Bulb Temperature (°C)	Dew Point (°C)	Relative Humidity (%)	Rainfall (Mean Daily) (mm)	Amount of Cloud (%)	Sunshine (Mean Daily) (hr)	Wind		
		Mean Daily Maximum (°C)	Mean (°C)	Mean Daily Minimum (°C)							Prevailing Direction (deg.)	Mean Speed (m/s)	
Jan	1 - 5	1020.3	19.3	17.1	15.3	14.3	11.8	72	0.8	51	5.4	70	24.8
	6 - 10	1020.5	19.0	16.8	14.9	14.0	11.4	72	0.5	54	5.5	70	24.1
	11 - 15	1020.1	18.7	16.4	14.4	13.7	11.1	72	0.8	60	4.7	70	25.6
	16 - 20	1019.9	18.6	16.4	14.5	14.0	11.8	75	0.7	63	4.6	60	25.2
	21 - 25	1019.8	18.1	15.8	14.0	13.5	11.4	75	1.1	72	3.5	60	26.3
	26 - 30	1020.8	17.7	15.5	13.7	13.0	10.6	74	1.0	66	3.9	10	24.5
	31 - 4	1020.2	18.3	16.0	14.2	13.7	11.5	76	0.8	67	4.0	70	25.2
Feb	5 - 9	1019.2	18.5	16.3	14.5	14.1	12.2	78	2.6	68	4.1	70	24.5
	10 - 14	1018.2	19.3	17.1	15.4	14.9	13.2	79	1.9	68	4.0	70	23.0
	15 - 19	1017.3	19.3	17.2	15.5	15.4	14.0	82	2.4	79	2.6	60	24.1
	20 - 24	1018.1	19.2	17.0	15.3	15.1	13.6	81	1.7	76	3.2	60	23.8
	25 - 1	1018.4	18.8	16.8	15.1	14.9	13.4	81	2.2	82	2.5	70	26.3
Mar	2 - 6	1017.9	20.1	17.6	15.6	15.1	13.0	76	2.7	69	4.0	60	23.8
	7 - 11	1017.8	20.3	18.0	16.2	15.9	14.2	80	0.7	74	3.6	60	24.1
	12 - 16	1015.6	21.9	19.4	17.5	17.8	16.6	84	1.6	82	2.6	50	20.9
	17 - 21	1014.9	22.0	19.6	17.7	17.8	16.6	84	2.6	83	2.5	60	22.0
	22 - 26	1014.7	22.2	19.9	18.2	18.2	17.0	84	4.5	86	2.0	70	24.1
	27 - 31	1014.7	22.7	20.3	18.6	18.5	17.4	84	3.8	81	2.9	70	22.0
Apr	1 - 5	1014.2	23.0	20.8	19.0	19.0	17.8	84	5.3	84	2.6	70	22.7
	6 - 10	1013.3	23.7	21.5	19.9	19.8	18.7	85	7.6	85	2.2	70	21.6
	11 - 15	1013.5	24.4	22.0	20.2	20.0	18.8	82	5.2	82	2.8	70	21.6
	16 - 20	1012.3	25.6	23.0	21.2	21.0	19.8	83	5.2	78	4.2	70	19.8
	21 - 25	1012.0	26.5	23.9	22.1	21.8	20.6	83	6.2	77	4.3	70	19.8
	26 - 30	1012.1	26.8	24.1	22.3	22.0	21.0	83	5.6	79	4.2	80	20.2
May	1 - 5	1010.7	27.4	24.8	22.9	22.8	21.8	84	9.8	79	4.0	80	19.1
	6 - 10	1010.2	28.1	25.4	23.6	23.2	22.1	82	10.8	74	5.1	80	16.9
	11 - 15	1010.1	28.7	26.1	24.3	23.8	22.7	82	6.0	73	5.3	80	19.1
	16 - 20	1009.1	28.6	26.1	24.2	23.7	22.5	82	10.1	74	4.6	80	21.6
	21 - 25	1008.2	28.5	26.2	24.5	24.0	23.0	83	8.9	78	4.0	80	21.2
	26 - 30	1007.8	29.0	26.7	25.0	24.5	23.5	83	12.3	78	4.1	80	19.8
	31 - 4	1007.0	29.6	27.3	25.5	24.9	23.9	83	11.3	76	4.7	90	21.2
Jun	5 - 9	1006.6	29.4	27.2	25.5	24.9	23.9	83	19.4	78	4.0	90	23.0
	10 - 14	1006.7	29.9	27.6	25.9	25.3	24.3	83	15.8	79	4.4	220	20.5
	15 - 19	1005.7	30.2	28.1	26.5	25.7	24.7	82	15.7	80	4.4	220	23.4
	20 - 24	1005.1	31.0	28.6	26.7	26.2	25.2	82	13.8	76	5.6	220	22.3
	25 - 29	1005.7	30.8	28.5	26.7	26.1	25.1	82	15.9	75	5.8	200	24.1
	30 - 4	1006.4	31.2	28.7	26.9	26.2	25.1	81	11.9	72	6.4	220	21.2
Observed at		The Observatory								King's Park	Waglan Island		

**Table 1 Five-day Normals of the Meteorological Elements for Hong Kong (Continued)
1981 – 2010**

		M.S.L. Pressure (hPa)	Air Temperature			Wet-Bulb Temperature (°C)	Dew Point (°C)	Relative Humidity (%)	Rainfall (Mean Daily) (mm)	Amount of Cloud (%)	Sunshine (Mean Daily) (hr)	Wind	
			Mean Daily Maximum (°C)	Mean (°C)	Mean Daily Minimum (°C)							Prevailing Direction (deg.)	Mean Daily Maximum (°C)
Jul	5 – 9	1005.9	31.3	28.8	26.8	26.0	24.9	80	9.6	70	6.6	230	21.6
	10 – 14	1005.9	31.6	29.0	26.8	26.2	25.0	80	11.0	67	7.6	230	19.4
	15 – 19	1005.7	31.4	28.8	26.8	26.1	25.1	80	16.1	69	6.9	230	22.3
	20 – 24	1006.3	31.3	28.8	26.7	26.2	25.1	81	14.3	69	7.2	230	22.0
	25 – 29	1004.8	31.3	28.7	26.7	26.1	25.0	81	11.6	68	6.4	230	20.2
	30 - 3	1004.7	31.3	28.8	26.8	26.2	25.1	81	13.0	69	6.3	230	20.5
Aug	4-8	1004.5	31.2	28.7	26.7	26.2	25.2	82	10.8	68	6.5	240	19.4
	9 – 13	1004.8	31.0	28.6	26.6	26.2	25.2	83	15.5	71	5.9	230	20.2
	14 – 18	1005.5	31.0	28.4	26.4	25.9	24.9	82	15.0	72	5.8	230	16.9
	19 – 23	1005.3	31.1	28.5	26.5	25.9	24.8	81	17.0	69	6.0	230	22.0
	24 – 28	1006.2	30.9	28.4	26.5	25.8	24.8	81	13.0	69	5.9	230	17.6
	29 - 2	1005.9	31.3	28.8	26.8	25.9	24.7	79	10.2	66	6.4	240	17.3
Sept	3 – 7	1007.0	30.5	28.2	26.3	25.6	24.5	81	11.6	70	5.6	90	20.9
	8 – 12	1008.1	30.5	28.0	26.1	25.2	23.9	79	10.4	65	6.0	80	20.2
	13 – 17	1008.7	30.2	27.8	25.9	24.8	23.4	78	18.2	64	5.7	90	21.6
	18 – 22	1009.6	30.0	27.6	25.7	24.5	23.0	77	8.5	66	5.7	90	23.0
	23 – 27	1010.7	29.4	27.1	25.3	24.0	22.5	77	8.0	65	5.7	80	27.4
	28 - 2	1011.8	29.2	26.8	25.1	23.8	22.3	77	5.6	64	5.6	80	26.6
Oct	3 – 7	1012.5	28.9	26.6	24.8	23.2	21.4	74	5.8	60	6.2	80	24.1
	8 – 12	1013.5	28.5	26.2	24.5	22.8	20.9	74	2.6	57	6.4	80	26.6
	13 – 17	1013.8	28.1	25.9	24.2	22.7	21.0	76	4.9	61	6.0	80	27.7
	18 – 22	1014.6	27.3	25.1	23.4	21.7	19.7	73	2.8	55	6.4	80	28.8
	23 – 27	1015.3	26.8	24.4	22.7	20.9	18.8	72	1.4	57	6.4	80	28.4
	28 – 1	1016.4	26.1	23.7	21.9	20.2	17.9	71	1.4	52	6.5	80	27.4
Nov	2 – 6	1017.0	25.4	23.2	21.3	19.7	17.4	71	2.1	53	6.2	80	28.1
	7 – 11	1016.6	25.1	22.7	20.8	19.3	17.0	71	0.9	54	6.3	80	26.6
	12 – 16	1017.2	24.5	22.2	20.2	19.0	16.9	73	1.7	61	5.3	70	25.9
	17 – 21	1018.6	23.2	20.8	18.9	17.5	15.0	70	1.2	53	6.2	80	28.4
	22 – 26	1018.2	23.3	21.1	19.1	17.8	15.3	71	0.7	53	6.2	80	25.6
	27 - 1	1019.4	22.1	19.7	17.7	16.3	13.4	69	0.9	51	5.8	70	27.0
Dec	2 – 6	1020.3	21.4	19.1	17.2	15.8	12.9	68	0.4	49	6.1	70	26.6
	7 – 11	1020.1	21.1	18.8	16.8	15.4	12.5	68	0.9	53	5.8	70	25.9
	12 – 16	1020.6	20.0	17.9	16.1	14.9	12.2	71	1.1	57	4.7	70	27.0
	17 – 21	1021.1	19.8	17.5	15.5	14.3	11.3	68	0.5	52	5.5	10	25.9
	22 – 26	1020.6	19.4	17.1	15.0	13.9	10.7	68	0.8	47	6.1	10	24.8
	27 - 31	1020.2	19.1	16.8	14.8	14.0	11.4	72	1.5	54	4.9	70	25.2
Observed at		The Observatory									King's Park	Waglan Island	

Table 2 Mean Sea Levels, Mean Higher High Water Levels and Mean Lower Low Water Levels

Location	Period of Data	Mean Sea Level (mPD)	Mean Higher High Water Level (mPD)	Mean Lower Low Water Level (mPD)
Ko Lau Wan ¹	1983-2019	1.26	2.00	0.51
Quarry Bay/North Point	1954- 2019	1.26	2.01	0.47
Tai O ²	1985-2019	1.27	2.13	0.31
Tai Po Kau	1963-2019	1.26	2.02	0.48
Tsim Bei Tsui	1974- 2019	1.31	2.32	0.26
Waglan Island ³	1976- 2018	1.40	2.08	0.66

Notes:

1. Ko Lau Wan tide station temporarily closed between 1996 and 2000 inclusive and there were no data records during the period.
2. Data period for analysis at Tai O tide station does not cover 1998-2010 inclusive.
3. Waglan Island tide station was damaged by Super Typhoon Mangkhut in 2018, the measurement of sea level at the station has been temporarily suspended since 16 September 2018.

Table 3 Extreme Sea Levels at Ko Lau Wan (1954-2019)

Return Period (years)	Sea Level (mPD)
2	2.79
5	2.99
10	3.11
20	3.24
50	3.43
100	3.58
200	3.72

Note The data are relative to the AR6 base year (1995-2014). The extreme sea levels at Ko Lau Wan were based on frequency analysis of instrumental data and correlated data of North Point/ Quarry Bay with an extended data set of 66 years (from 1954 to 2019).

Table 4 Extreme Sea Levels at Quarry Bay/North Point (1954-2019)

Return Period (years)	Sea Level (mPD)
2	2.82
5	3.03
10	3.20
20	3.38
50	3.66
100	3.91
200	4.19

Note The extreme sea levels at Quarry Bay / North Point were based on frequency analysis of instrumental data from 1954 to 2019 (66 years) and adjusted by +0.07m to AR6 base year (1995-2014).

Table 5 Extreme Sea Levels at Tai Po Kau (1962-2019)

Return Period (years)	Sea Level (mPD)
2	2.97
5	3.27
10	3.54
20	3.86
50	4.41
100	4.93
200	5.59

Note The extreme sea levels at Tai Po Kau were based on frequency analysis of instrumental data from 1962 to 2019 (58 years) and adjusted by +0.04m to AR6 base year (1995-2014).

Table 6 Extreme Sea Levels at Tsim Bei Tsui (1954-2019)

Return Period (years)	Sea Level (mPD)
2	3.07
5	3.31
10	3.52
20	3.74
50	4.09
100	4.41
200	4.78

Note The data are relative to the AR6 base year (1995-2014). The extreme sea levels at Tsim Bei Tsui were based on frequency analysis of instrumental data and correlated data of North Point/ Quarry Bay with an extended data set of 66 years (from 1954 to 2019).

Table 7 Extreme Sea Levels at Waglan Island (1954-2019)

Return Period (years)	Sea Level (mPD)
2	2.79
5	2.95
10	3.09
20	3.24
50	3.45
100	3.62
200	3.81

Note The data are relative to the AR6 base year (1995-2014). The extreme sea levels at Waglan Island were based on frequency analysis of instrumental data and correlated data of North Point/ Quarry Bay with an extended data set of 66 years (from 1954 to 2019).

Table 8 Extreme Sea Levels at Chi Ma Wan (1954-2019)

Return Period (years)	Sea Level (mPD)
2	2.86
5	3.07
10	3.23
20	3.41
50	3.65
100	3.85
200	4.08

Note The data are relative to the AR6 base year (1995-2014). The extreme sea levels at Chi Ma Wan were based on frequency analysis of instrumental data and correlated data of North Point/ Quarry Bay with an extended data set of 66 years (from 1954 to 2019).

Table 9 Extreme Sea Levels at Lok On Pai (1981-1999)

[Not in use due to decommission of tide station in 1999]

Table 9A Extreme Sea Levels at Tai O (1954-2019)

Return Period (years)	Sea Level (mPD)
2	2.87
5	3.16
10	3.36
20	3.57
50	3.84
100	4.06
200	4.28

Note The data are relative to the AR6 base year (1995-2014). The extreme sea levels at Tai O were based on frequency analysis of instrumental data and correlated data of North Point/ Quarry Bay with an extended data set of 66 years (from 1954 to 2019).

Table 10 Observed Minimum Sea Levels

Location	Period of Data	Minimum Sea Levels (mPD)
Ko Lau Wan	1974-2019	-0.28
Quarry Bay	1954- 2019	-0.30
Tai O	1985-2019	-0.67
Tai Po Kau	1963- 2019	-0.48
Tsim Bei Tsui	1974- 2019	-0.36
Waglan Island	1976- 2018	-0.32

Notes:

1. Ko Lau Wan tide station temporarily closed between 1996 and 2000 inclusive and there were no data records during the period.
2. Data period for analysis at Tai O tide station does not cover 1998-2010 inclusive.
3. Waglan Island tide station was damaged by Super Typhoon Mangkhut in 2018, the measurement of sea level at the station has been temporarily suspended since 16 September 2018.

Table 11 Probable Minimum Sea Levels at Quarry Bay/North Point (1954-Oct 2017)

Return Period (years)	Sea Level (mPD)
2	-0.16
5	-0.26
10	-0.32
20	-0.37
50	-0.42
100	-0.45
200	-0.48

**Table 12 Mean Hourly Wind Speeds (m/s) – Kai Tak Southeast Station
(1968-2020)**

Return Period (Years)	N	NE	E	SE	S	SW	W	NW
5	13	14	17	16	13	14	13	12
10	15	16	20	19	16	16	16	14
20	17	18	23	21	18	19	18	16
50	20	21	27	25	21	23	21	18
100	22	23	30	27	23	27	23	20
200	24	25	34	30	26	29	25	21

**Table 13 Mean Hourly Wind Speeds (m/s) – Cheung Chau Station
(1953- 2020)**

Return Period (Years)	N	NE	E	SE	S	SW	W	NW
5	19	21	25	24	20	18	17	18
10	22	24	29	29	23	21	20	21
20	24	27	33	33	27	24	22	25
50	27	31	37	38	32	29	26	29
100	30	35	41	42	37	33	29	31
200	32	38	44	46	41	36	31	34

**Table 14 Mean Hourly Wind Speeds (m/s) – Waglan Island Station
(1953-2020)**

Return Period (Years)	N	NE	E	SE	S	SW	W	NW
5	22	26	28	25	23	23	20	17
10	24	30	32	29	27	26	23	20
20	26	34	35	33	31	29	26	24
50	29	39	40	39	36	33	30	28
100	31	44	44	43	39	36	34	32
200	33	48	47	47	43	40	37	37

Table 14A Mean Hourly Wind Speeds (m/s) – Hong Kong International Airport Station (1979-1983, 1997-2020)

Return Period (Years)	N	NE	E	SE	S	SW	W	NW
5	15	15	21	17	14	18	16	17
10	17	17	23	20	16	21	19	19
20	19	20	26	22	18	25	23	21
50	21	22	29	25	21	31	28	24
100	23	25	31	27	23	36	32	26
200	24	27	34	29	25	42	36	28

Table 15 Mean Wind Speeds East Direction (m/s) – Kai Tak Southeast Station (1968-2020)

Return Period (Years)	Duration (hr)					
	1	2	3	4	6	10
5	17	17	17	16	16	15
10	20	20	19	19	18	17
20	23	23	22	22	21	19
50	27	27	26	26	24	22
100	30	30	29	29	27	24
200	34	34	33	32	31	26

Table 16 Mean Wind Speeds Southeast Direction (m/s) – Kai Tak Southeast Station (1968-2020)

Return Period (Years)	Duration (hr)					
	1	2	3	4	6	10
5	16	15	14	14	13	12
10	19	17	16	16	15	14
20	21	20	19	18	17	16
50	25	22	21	21	19	18
100	27	25	23	23	21	20
200	30	27	25	24	23	21

Table 17 Mean Wind Speeds West Direction (m/s) – Kai Tak Southeast Station (1968- 2020)

Return Period (Years)	Duration (hr)					
	1	2	3	4	6	10
5	13	13	12	12	11	10
10	16	15	14	14	13	12
20	18	17	16	15	14	13
50	21	19	18	18	16	15
100	23	21	20	19	18	16
200	25	22	22	21	19	17

Table 18 Mean Wind Speeds North Direction (m/s) – Cheung Chau Station (1953-2020)

Return Period (Years)	Duration (hr)					
	1	2	3	4	6	10
5	19	19	18	18	17	16
10	22	21	20	20	19	18
20	24	23	23	22	21	20
50	27	26	26	25	24	22
100	30	29	28	27	26	24
200	32	31	31	30	27	25

Table 19 Mean Wind Speeds Northeast Direction (m/s) – Cheung Chau Station (1953- 2020)

Return Period (Years)	Duration (hr)					
	1	2	3	4	6	10
5	21	19	19	18	17	16
10	24	22	21	21	19	18
20	27	25	24	23	22	20
50	31	29	28	27	25	22
100	35	32	30	29	27	24
200	38	35	33	32	30	26

Table 20 Mean Wind Speeds East Direction (m/s) – Cheung Chau Station (1953-2020)

Return Period (Years)	Duration (hr)					
	1	2	3	4	6	10
5	25	24	23	23	21	20
10	29	28	27	26	25	23
20	33	31	30	29	28	26
50	37	36	35	34	32	29
100	41	39	38	37	35	32
200	44	43	41	40	38	35

Table 21 Mean Wind Speeds Southeast Direction (m/s) – Cheung Chau Station (1953-2020)

Return Period (Years)	Duration (hr)					
	1	2	3	4	6	10
5	24	23	22	22	21	19
10	29	28	26	26	25	23
20	33	32	30	29	28	26
50	38	37	35	34	33	30
100	42	41	39	38	36	33
200	46	45	43	42	39	36

Table 22 Mean Wind Speeds South Direction (m/s) – Cheung Chau Station (1953-2020)

Return Period (Years)	Duration (hr)					
	1	2	3	4	6	10
5	20	19	18	18	17	15
10	23	22	22	21	20	18
20	27	26	25	24	23	20
50	32	31	30	29	27	24
100	37	36	34	32	30	26
200	41	40	38	36	33	29

Table 23 Mean Wind Speeds Southwest Direction (m/s) – Cheung Chau Station (1953-2020)

Return Period (Years)	Duration (hr)					
	1	2	3	4	6	10
5	18	17	16	16	15	14
10	21	20	19	19	18	16
20	24	23	22	22	21	19
50	29	27	27	26	25	22
100	33	31	30	29	28	25
200	36	35	34	33	32	28

Table 24 Mean Wind Speeds North Direction (m/s) - Waglan Island Station (1953-2020)

Return Period (Years)	Duration (hr)					
	1	2	3	4	6	10
5	22	22	21	21	20	19
10	24	24	23	23	22	21
20	26	26	25	25	24	22
50	29	29	28	27	26	24
100	31	31	30	29	28	26
200	33	33	32	31	29	27

Table 25 Mean Wind Speeds Northeast Direction (m/s) - Waglan Island Station (1953-2020)

Return Period (Years)	Duration (hr)					
	1	2	3	4	6	10
5	26	25	25	24	23	21
10	30	29	28	27	26	24
20	34	33	32	30	29	27
50	39	38	36	35	33	31
100	44	42	40	38	36	34
200	48	46	43	42	40	36

**Table 26 Mean Wind Speeds East Direction (m/s) - Waglan Island Station
(1953-2020)**

Return Period (Years)	Duration (hr)					
	1	2	3	4	6	10
5	28	28	27	26	26	24
10	32	31	30	30	28	26
20	35	34	34	33	31	29
50	40	39	38	37	35	32
100	44	42	41	40	38	34
200	47	46	44	43	41	37

**Table 27 Mean Wind Speeds Southeast Direction (m/s) - Waglan Island Station
(1953-2020)**

Return Period (Years)	Duration (hr)					
	1	2	3	4	6	10
5	25	24	23	22	21	20
10	29	28	27	26	25	23
20	33	32	31	30	28	26
50	39	37	36	35	33	30
100	43	41	40	39	37	34
200	47	45	44	43	41	37

**Table 28 Mean Wind Speeds South Direction (m/s) - Waglan Island Station
(1953-2020)**

Return Period (Years)	Duration (hr)					
	1	2	3	4	6	10
5	23	22	21	20	19	18
10	27	26	25	24	23	21
20	31	29	28	27	26	24
50	36	34	33	32	30	28
100	39	38	37	36	34	31
200	43	42	40	39	37	34

Table 29 Mean Wind Speeds Southwest Direction (m/s) - Waglan Island Station (1953-2020)

Return Period (Years)	Duration (hr)					
	1	2	3	4	6	10
5	23	22	21	20	19	18
10	26	25	24	24	22	20
20	29	28	27	26	25	22
50	33	32	31	30	28	25
100	36	35	34	33	31	27
200	40	38	37	36	33	29

Table 30 Mean Wind Speeds West Direction (m/s) - Waglan Island Station (1953-2020)

Return Period (Years)	Duration (hr)					
	1	2	3	4	6	10
5	20	19	18	18	17	16
10	23	22	21	20	19	18
20	26	25	24	23	22	20
50	30	29	27	26	25	23
100	34	32	30	28	27	25
200	37	35	33	31	29	27

Table 30A Mean Wind Speeds North Direction (m/s) – Hong Kong International Airport Station (1979-1983, 1997-2020)

Return Period (Years)	Duration (hr)					
	1	2	3	4	6	10
5	15	14	14	14	13	12
10	17	16	16	15	15	13
20	19	18	18	17	17	15
50	21	20	20	20	19	17
100	23	22	22	22	21	19
200	24	24	24	24	23	21

Table 30B Mean Wind Speeds Northeast Direction (m/s) – Hong Kong International Airport Station (1979-1983, 1997-2020)

Return Period (Years)	Duration (hr)					
	1	2	3	4	6	10
5	15	15	14	13	12	11
10	17	17	16	15	14	13
20	20	19	18	17	15	14
50	22	21	20	19	17	15
100	25	23	22	21	19	17
200	27	25	24	22	20	18

Table 30C Mean Wind Speeds Southeast Direction (m/s) – Hong Kong International Airport Station (1979-1983, 1997-2020)

Return Period (Years)	Duration (hr)					
	1	2	3	4	6	10
5	17	16	16	15	14	13
10	20	18	18	17	16	15
20	22	20	19	19	18	17
50	25	23	22	21	20	19
100	27	25	24	22	21	20
200	29	27	25	24	23	22

Table 30D Mean Wind Speeds Southwest Direction (m/s) – Hong Kong International Airport Station (1979-1983, 1997-2020)

Return Period (Years)	Duration (hr)					
	1	2	3	4	6	10
5	18	16	16	15	14	13
10	21	20	19	18	16	14
20	25	23	22	20	18	16
50	31	28	26	24	21	17
100	36	33	30	27	23	19
200	42	38	35	31	25	20

Table 30E Mean Wind Speeds West Direction (m/s) – Hong Kong International Airport Station (1979-1983, 1997-2020)

Return Period (Years)	Duration (hr)					
	1	2	3	4	6	10
5	16	15	14	14	12	11
10	19	18	17	16	15	13
20	23	21	20	19	17	15
50	28	26	24	22	20	17
100	32	29	27	25	22	19
200	36	32	30	27	24	21

Table 30F Mean Wind Speeds Northwest Direction (m/s) – Hong Kong International Airport Station (1979-1983, 1997-2020)

Return Period (Years)	Duration (hr)					
	1	2	3	4	6	10
5	17	16	15	15	14	13
10	19	18	17	17	16	14
20	21	20	19	18	17	15
50	24	23	22	21	19	17
100	26	24	23	22	21	19
200	28	26	25	24	22	20

Table 30G Brief History of the Anemometers at the Four Wind Stations

Wind Station	Time Period	Anemometer height (above MSL) to the nearest meter	Location
Waglan Island	1952-1964	70	Only small distance relocation within buildings on the island
	1964-1966	67	
	1966-1989	75	
	1989-now	83	
Cheung Chau	1953-1971	48	Old site near Cheung Chau Sports Ground
	1971-1992	92	At Cheung Chau Aeronautical Meteorological Station
	1992-now	98	
Kai Tak Southeast	1948-1962	16	At old Kai Tak Meteorological Station
	1962-1974	10	Near south-eastern end of the runway
	1974-now	16	Near south-eastern end of the extended runway
Hong Kong International Airport	1979-1983	65	On Chek Lap Kok Island
	1997-now	14	At central part of the Center Runway* of HKIA

* Known as “North Runway” before 8:00 HKT on 2 December 2021

Table 31 Relationship of Higher Wave Heights with Significant Wave Height

Higher Wave Heights in a Rayleigh Distribution	Relationship with $H_{1/3}$
H_{\max} (Most probable largest wave height)	$0.706\sqrt{\ln N_0}$
$H_{1/100}$ (Average of the highest 1 percent of all waves)	$1.67 H_{1/3}$
$H_{1/20}$ (Average of the highest 5 percent of all waves)	$1.40 H_{1/3}$
$H_{1/10}$ (Average of the highest 10 percent of all waves)	$1.27 H_{1/3}$

Notes : 1. The wave periods of these higher wave heights can be taken as equal to the significant wave period.
2. N_0 is the number of waves during a peak of storm events.

Table 32 Wave Measurement at Kau Yi Chau Station (1994-2020)

Year	Percentage of Time in Service	Calm Period ($H_{m0} < 0.3m$)	Average H_{m0} (m)	Average Peak Period T_p (s)	Maximum H_{m0} (m) [T_p (s)]	Maximum Recorded Wave Height H_{max} (m)
1994	78%	63%	0.31	6.74	1.46 [9.14]	2.45
1995	87%	77%	0.26	6.47	1.51 [11.63]	2.68
1996	60%	75%	0.27	6.33	1.57 [11.63]	2.38
1997	95%	79%	0.26	6.65	1.61 [11.63]	2.68
1998	97%	81%	0.24	6.38	1.40 [9.14]	2.92
1999	93%	75%	0.25	6.15	2.37 [9.85]	3.75
2000	100%	73%	0.27	6.38	1.70 [9.14]	2.33
2001	73%	70%	0.29	6.29	2.68 [10.67]	3.87
2002	96%	79%	0.26	6.12	2.46 [11.64]	3.42
2003	85%	78%	0.27	6.30	2.68 [12.8]	3.44
2004	86%	69%	0.28	5.63	1.33 [6.67&9.53]	2.13
2005	84%	58%	0.31	5.62	1.73 [13.21]	2.65
2006	72%	58%	0.32	6.04	2.47 [11.7]	3.83
2007	51%	40%	0.35	5.26	1.75 [3.95]	2.83
2008	67%	39%	0.41	5.32	3.31 [12.26]	5.31
2009	79%	39%	0.52	5.11	3.34 [12.26]	5.45
2010	80%	60%	0.37	5.05	2.89 [3.64]	4.82
2011	94%	78%	0.17	4.90	2.29 [10.72]	3.52
2012	86%	77%	0.18	5.08	2.59 [10.5]	4.14
2013	76%	81%	0.15	4.99	1.72 [11.98]	2.70
2014	58%	61%	0.31	5.42	2.07 [3.66]	3.35
2015	75%	11%	0.47	4.50	1.86 [10.95]	2.96
2016	55%	70%	0.16	4.56	0.97 [8.57]	1.55
2017	54%	65%	0.23	5.55	1.36 [10.95]	2.13
2018	66%	54%	0.30	6.16	4.32 [14.32]	6.80
2019	81%	63%	0.29	6.06	1.35 [10.5]	2.11
2020	59%	26%	0.38	5.83	1.65 [7.56]	2.47

Note 1. The percentage of time in service refers to the time at which the recorder is operational.

2. For the maximum H_{m0} , the corresponding peak period T_p is shown in brackets.

3. For data beyond 2020, CEDD website <https://www.cedd.gov.hk/> should be referred.

Table 33 Wave Measurement at West Lamma Channel Station (1994-2020)

Year	Percentage of Time in Service	Calm Period ($H_{m0} < 0.3\text{m}$)	Average H_{m0} (m)	Average Peak Period T_p (s)	Maximum H_{m0} (m) [T_p (s)]	Maximum Recorded Wave Height H_{max} (m)
1994	84%	55%	0.33	7.51	1.68 [9.14]	2.42
1995	53%	46%	0.36	7.29	1.45 [3.88]	2.47
1996	41%	56%	0.32	7.08	1.71 [11.63]	2.83
1997	71%	60%	0.28	6.66	2.52 [5.82]	3.99
1998	34%	51%	0.32	7.99	1.08 [12.8]	1.93
1999	51%	50%	0.33	7.34	3.28 [9.85]	4.68
2000	72%	38%	0.38	6.49	1.95 [9.85]	3.01
2001	77%	45%	0.35	6.60	3.03 [10.67]	4.01
2002	27%	52%	0.33	7.40	2.29 [10.67]	3.41
2003	78%	45%	0.36	6.64	3.38 [12.8]	5.45
2004	75%	32%	0.37	6.36	1.59 [10.29]	2.57
2005	89%	43%	0.35	6.89	2.01 [11.98]	3.11
2006	77%	41%	0.37	7.29	2.99 [10.95]	4.64
2007	82%	47%	0.34	6.95	2.29 [5.97&7.79]	3.69
2008	95%	41%	0.36	7.24	3.49 [13.93]	5.46
2009	97%	34%	0.36	7.19	2.81 [11.19]	4.47
2010	99%	39%	0.33	6.87	1.33 [10.10]	2.24
2011	72%	54%	0.29	6.07	2.81 [13.56]	4.34
2012	88%	60%	0.22	5.94	0.72 [5.97]	1.18
2013	99%	75%	0.15	5.45	1.79 [11.19]	2.84
2014	99%	51%	0.28	6.41	2.47 [11.7]	3.89
2015	75%	52%	0.27	6.57	1.76 [10.09]	2.77
2016	90%	39%	0.36	6.73	2.08 [5.83]	3.40
2017	67%	29%	0.39	6.58	1.65 [10.72]	2.61
2018	71%	48%	0.31	6.16	4.37 [14.73]	6.81
2019	81%	34%	0.35	6.55	0.94 [7.67]	1.49
2020	43%	16%	0.43	6.56	1.43 [12.02]	2.39

Note 1. The percentage of time in service refers to the time at which the recorder is operational.
2. For the maximum H_{m0} , the corresponding peak period T_p is shown in brackets.
3. For data beyond 2020, CEDD website <https://www.cedd.gov.hk/> should be referred.

Table 34 Offshore Wave Data from Storm Hindcasting

Return Period	Significant Wave Height (m)	
	Location (114°9'E, 21°47'N)	Location (114°40'E, 21°55'N)
2	5.2	5.2
5	7.3	7.6
10	8.7	9.2
20	10.0	10.7
50	11.7	12.7
100	13.0	14.2
200	14.3	15.6

Note

- The wave period may be estimated from the following formula :

$$2 \pi H_{1/3}/(gT_{1/3}^2) = 0.03 \text{ to } 0.06.$$

The critical period needs to be tested in design.
- The offshore locations are shown in Figure 8.

Table 35 Effect of Waves on Harbour Activities

Wave Region in Figure 9	Wave Effects on Harbour Activities
Region 1	No severe wave impacts on harbour activities, ship navigation conditions and cargo handling occur under normal weather conditions. Wave field variation from daytime to night is not significant. The average measured significant wave height in this region is less than 0.3 m.
Region 2	Wave conditions affect harbour activities of small sized passenger vessels and cargo boats. Navigation is acceptable. Waves become considerably strong during peak navigation hours. Degree of ship movement is still in acceptable range. The average measured significant wave height in this region is between 0.3 m to 0.4 m.
Region 3	The average measured significant wave height in this region is between 0.4 m and 0.5 m. Degree of ship movement, however, is sometimes unacceptable during the period of intensive harbour navigation. In such period, harbour activities of small to middle sized vessels are affected, and vessel berthing and cargo handling may become difficult.
Region 4	The wave region is limited to the area which receives direct incident waves. Sea state is very rough and navigation of small to middle sized vessels in this area becomes difficult. Wave climate in the area is considerably improved at night when most navigation activities come to a halt. The average measured significant wave height in this region is greater than 0.5 m.

Table 36 Basic Characteristics of Vessels - Local Craft Register (January 2000)

Type/ Category of Vessel	No. of Vessels Licensed			Approximate Dimensions (m)			Draft (m)	Displacement (t)	Carrying Capacity	Service Speed (m/s)
	Mech.	Non-Mech.	Total	Length O.A.	Beam	Depth				
1. Motor Launches & Ferry Vessels	801	-	801	10.5 - 62.0	2.6 - 19.1	1.0 - 4.0	0.5 - 3.0	15 - 3000	7 - 1400 pass.	3 - 17
2. Class I Passenger Sampans	120	55	175	3.7 - 7.9	2.1 - 4.8	0.7 - 1.0	0.3 - 0.7	4 - 25	1 - 5 pass.	-
3. Class II Wooden, Steel Cargo / Work Barges	396	1040	1436	6.1 - 96.2	2.8 - 29.8	2.0 - 4.0	1.0 - 3.0	25 - 3200	25 - 2200 t	2 - 4
4. Class III Stationary Craft	-	248	248	3.0 - 176.5	1.4 - 21.0	1.0 - 4.0	0.7 - 3.0	13 - 6200	-	-
5. Class IV Fishing, Misc. Craft	3667	983	4650	2.4 - 49.9	1.0 - 26.7	0.7 - 4.0	0.3 - 3.0	20 - 3200	15 - 2200 t	2 - 5
6. Class V Trading Vessels	58	-	58	7.7 - 36.1	3.3 - 8.5	1.0 - 3.0	0.7 - 2.5	20 - 40	5 - 6 t	5 - 7
7. Class VI Fishing Vessels	2667	1	2668	7.3 - 39.3	2.9 - 19.3	1.0 - 2.0	0.7 - 1.5	16 - 350	-	3 - 15
8. Class VII Floating Dock / Workshops	-	8	8	23.2 - 270.0	8.5 - 57.5	2.0 - 3.0	1.0 - 2.5	150 - 58000	-	-
9. Class VIII Float Restaurant	-	3	3	52.5 - 76.2	15.1 - 22.3	-	-	-	-	-
10. Various Classes Pleasure Vessels	5171	-	5171	2.1 - 64.6	1.1 - 11.3	0.3 - 5.0	0.2 - 4.5	0.5 - 800	1 - 200 pass.	2 - 30
11. HK Registered - Passenger Ferries	76	-	76	16.0 - 200.0	4.9 - 44.0	2.0 - 13.0	1.0 - 4.0	50 - 1300	10 - 1400 pass.	3 - 25
12. HK Registered - Container Ships	31	-	31	177 - 264	27.6 - 40.0	14.7 - 21.3	8.0 - 14.0	18000 - 72000	-	8 - 13
Total	12987	2338	15325							

Mechanical Non-Mech. = Non-mechanical

Pass. = Passenger

Table 37 Basic Characteristics of Vessels (August 2000)

Type & Name of Vessels	Length Overall (1) (m)	Beam (2) (m)	Depth (3) (m)	Draft (4)		Displacement (5)		Wind Presentment Area (6)		Service Speed (m/s)	Name of Fleet
				Fully Loaded (m)	Light (m)	Fully Loaded (t)	Light (t)	Broadside (sq. m)	Frontal (sq. m)		
Celestial Star Meridian Star Solar Star Northern Star Night Star Shining Star Day Star Twinkling Star Morning Star Silver Star	36.3	8.6	2.6	2.4	2.1	302.6	246.8	212.0	54.0	5.7	The Star Ferry Fleet
Pacific Princess	44.5	7.9	3.8	2.1	1.9	277.6	243.3	234.6	59.1	6.2	
Golden Star World Star	46.0	9.3	3.6	2.1	1.7	426.1	317.0	301.5	62.3	6.0	
High Speed Catamaran Universal MK1 – MK4	40.0	10.1	14.0	1.6	1.3	140.0	108.0	-	-	16.5	Shun Tak TurboJet Fleet

The notes are shown at the end of this table.

Table 37 Basic Characteristics of Vessels (August 2000)(Continued)

Type & Name of Vessels	Length Overall (1) (m)	Beam (2) (m)	Depth (3) (m)	Draft (4)		Displacement (5)		Wind Presentment Area (6)		Service Speed (m/s)	Name of Fleet
				Fully Loaded (m)	Light (m)	Fully Loaded (t)	Light (t)	Broadside (sq. m)	Frontal (sq. m)		
Waterjet Catamaran (Discovery Bay 1 – 3)	42.0	11.5	3.8	1.3	-	168.0	-	-	-	16.5	Discovery Bay Ferry Fleet
(Discovery Bay 5 – 8)	43.0	11.5	3.8	1.3	-	168.0	-	-	-	17.0	
(DB Support)	26.2	8.0	3.2	1.2	-	132.0	-	-	-	13.0	
Waterjet Monohull (Discovery Bay 12, 15, 16, 19 – 22)	35.5	7.7	2.9	1.2	-	93.0	-	-	-	12.5	
GRP Launch (Discovery Bay 23, 25 & 26)	19.7	5.4	3.0	1.7	-	43.0	-	-	-	9.5	
HM218 Hovercraft (RTS 201 – 203)	18.3	6.1	2.1	1.1	-	28.4	-	-	-	14.0	

The notes are shown at the end of this table.

Table 37 Basic Characteristics of Vessels (August 2000)(Continued)

Type & Name of Vessels	Length Overall (1) (m)	Beam (2) (m)	Depth (3) (m)	Draft (4)		Displacement (5)		Wind Presentment Area (6)		Service Speed (m/s)	Name of Fleet
				Fully Loaded (m)	Light (m)	Fully Loaded (t)	Light (t)	Broadside (sq. m)	Frontal (sq. m)		
Single End Triple Deck	59.4 -65.0	10.5 -11.6	3.6 -4.3	2.3 -3.0	-	936.6	780.6	530.1	122.8	6.7 -8.2	First Ferry Fleet
Single End Double Deck	44.2	8.2	3.4	2.4	-	289.9	227.9	268.2	52.8	5.1 -6.1	
Propeller Catamaran	25.0 - 28.0	8.7 -8.9	2.6 -2.8	1.8	1.6	81.6 -81.8	70.4	139.0	50.5	11.8	
Waterjet Catamaran	40.0	10.1	4.0	1.7	1.3	136.0	104.0	214.5	97.0	17.0	
Passenger Ship Star Pisces	176.0	29.0	-	6.5	6.3	19184.0	16500.0	4840.0	895.0	20.0	Star Cruise Fleet

Notes:

1. Length overall is the extreme length of the vessel measured from the foremost point of the stem to the aftermost part of the stem.
2. Beam is the maximum breadth of the vessel.
3. Depth is the vertical distance from the vessel's base line or keel to the top of the deck, measured at mid-length of the vessel.
4. Fully loaded and light drafts are the mean depths of the vessel below the waterline measured vertically to the vessel's base line or keel under full load condition and unloaded condition respectively.
5. Fully loaded displacement is the maximum displacement of the vessel measured in tonnage when floating at its greatest allowable draft. Light displacement is the minimum displacement of the vessel.
6. Broadside and frontal wind presentment areas are respectively the maximum longitudinal and transverse cross-sectional areas of the vessel above waterline including hull and superstructures, which are wind resisting.

Table 38 Geology of Offshore Sediments in Hong Kong

Formation	Material Type	Environment of Deposition	Age
Hang Hau Formation	Mainly very soft to soft, olive-grey clayey silts with fine sand lenses and shells. Grey muddy sands and sandy muds	Shallow marine Littoral Estuarine	Holocene
Waglan Formation	Firm, grey, shelly, clayey silt. Interbedded shelly sand and clayey silt	Shallow marine Littoral	Late Pleistocene
Sham Wat Formation	Soft to firm grey, silty clays with light yellow mottles and thin sand bands	Fluctuating open marine and brackish water conditions	Late Pleistocene
Chek Lap Kok Formation	Diverse lithology. Comprising firm to stiff silts and clays, and dense, poorly-sorted sands and gravels	Fluvial channel Alluvial plain Estuarine	Middle to Late Pleistocene

Table 39 Engineering Properties of Hong Kong Marine Mud
(K.S. Ho & Y.C. Chan, 1994)

Soil Properties	Range of Values
Organic matter (%)	2.6 - 4.1
Sulphur content (%)	0.2 - 2.0
Salt content in pore water (%)	1.0 - 3.5
Liquid limit (%)	20 - 100
Plasticity index (%)	10 - 60
Ratio of undrained shear strength to maximum past pressure	0.22 - 0.39
Compression index	0.4 - 1.0
Coefficient of consolidation (m ² /year)	0.3 - 3.5
Sensitivity	4 - 12
Permeability (m/s)	10 ⁻¹⁰ - 10 ⁻⁸
Moisture content (%)	Variable, up to 100

Table 40 Typical Soil Tests

Tests	Soil Tested	Information Revealed
Field tests :		
Vane shear test	<ul style="list-style-type: none"> ● Silty/clayey deposit 	<ul style="list-style-type: none"> ● Undrained shear strength
Static cone penetration test	<ul style="list-style-type: none"> ● Silty/clayey deposit ● Sandy deposit ● Highly or completely decomposed bedrock, residual soil ● Generally not suitable for gravel and stiff clays 	<ul style="list-style-type: none"> ● Soil profile ● Interpretation of soil type from cone resistance and friction with reasonable accuracy ● Strength indication ● Interpolation of information between boreholes
Standard penetration test	<ul style="list-style-type: none"> ● Sandy deposit ● Highly or completely decomposed bedrock, residual soil 	<ul style="list-style-type: none"> ● Soil type and profile ● Strength indication
Laboratory tests :		
Unconsolidated undrained triaxial compression test	<ul style="list-style-type: none"> ● Silty/clayey deposit 	<ul style="list-style-type: none"> ● Undrained shear strength
Consolidated drained/undrained triaxial compression tests	<ul style="list-style-type: none"> ● Silty/clayey deposit ● Sandy deposit ● Highly or completely decomposed bedrock, residual soil 	<ul style="list-style-type: none"> ● Effective shear strength parameters
Direct shear test	<ul style="list-style-type: none"> ● Cohesive and cohesiveless soils 	<ul style="list-style-type: none"> ● Shear strength parameters
One-dimensional consolidation test (Oedometer test)	<ul style="list-style-type: none"> ● Silty/clayey deposit 	<ul style="list-style-type: none"> ● Coefficient of consolidation ● Coefficient of volume compressibility ● Coefficient of secondary compression ● Preconsolidation pressure
Isotropic compression test	<ul style="list-style-type: none"> ● Soil of sedimentary origin containing laminations of sand and silt ● Highly or completely decomposed bedrock, residual soil 	<ul style="list-style-type: none"> ● Coefficient of consolidation ● Coefficient of volume compressibility ● Preconsolidation pressure
Heavy metal, organic and biological tests	<ul style="list-style-type: none"> ● Soils down to the base of the layer to be dredged 	<ul style="list-style-type: none"> ● Sediment classification according to WBTC 3/2000 ● Depth of contamination
<p>Note : 1. The coefficient of horizontal consolidation of silty/clayey deposit may also be determined from the Rowe Cell Consolidation Test. Reference on the test can be made to : (a) Head (1985) – Manual of Soil Laboratory Testing Volume 3 : Effective Stress Tests, pp 1129-1225; and (b) GEO (1996) – Conventional and CRS Rowe Cell Consolidation Test on Some Hong Kong Clays, GEO Report No. 55.</p> <p>2. WBTC 3/2000 – Works Bureau Technical Circular 3/2000 : Management of Dredged/Excavated Sediment.</p>		

Table 41 Design Parameters for Concrete and Steel Reinforcement*I. Concrete*

Parameter	Recommended Value
Compressive strength	Design equations based on cylinder strength (f_{ck}) determined at 28 days, with its equivalent cube strength ($f_{ck,cube}$) given in Table 3.1 of BS EN 1992-1-1:2004 (BSI, 2004a)
Exposure condition	Tidal and splash zones – XS3 Submerged zone – XS2 Aerated zone – XS1
Concrete grade	$f_{ck, cube} = 50$ MPa or above (for XS1, XS2 and XS3)
Nominal concrete cover	60 mm (for XS1) 75 mm (for XS2 and XS3)
Design crack width	Section 3.5.1 of Part 2 of this Manual
Stress-strain curve	Figure 3.8 of (BD, 2020)
Modulus of elasticity	Table 3.2 of (BD, 2020)
Coefficient of thermal expansion	Section 3.1.9 of (BD, 2020)
Drying shrinkage	Section 3.1.8 of (BD, 2020)

II. Steel Reinforcement

Parameter	Recommended Value
Yield strength	500 MPa
Modulus of elasticity	200 GPa

Table 42 Rise in Mean Sea Levels Due to Climate Change

Years	Sea Level Rise (m)
2030	0.09
2040	0.14
2050	0.20
2060	0.26
2070	0.32
2080	0.39
2090	0.47
2100	0.56

Note The mean sea level rise is relative to the average of 1995-2014.
Median projection values are adopted in the table.

Table 43 Increase in Extreme Wind Speeds Due to Climate Change

Wind Speed Increase (%)	Type	Year 2050	Year 2090
	Typical Marine Structure	3.3	6.7
	Critical Infrastructure	3.6	6.9

Table 44 Storm Surge Increase Due to Climate Change

Return Period (years)	Location	Storm Surge Increase (m)	
		Year 2050	Year 2090
2	Quarry Bay/North Point	0.04	0.06
	Tai Po Kau	0.05	0.09
	Tsim Bei Tsui	0.05	0.09
	Tai O	0.03	0.06
	Waglan Island	0.03	0.06
	Ko Lau Wan	0.04	0.07
	Chi Ma Wan	0.04	0.08
5	Quarry Bay/North Point	0.05	0.09
	Tai Po Kau	0.07	0.14
	Tsim Bei Tsui	0.06	0.12
	Tai O	0.05	0.09
	Waglan Island	0.05	0.08
	Ko Lau Wan	0.06	0.10
	Chi Ma Wan	0.06	0.11
10	Quarry Bay/North Point	0.06	0.10
	Tai Po Kau	0.08	0.17
	Tsim Bei Tsui	0.08	0.15
	Tai O	0.05	0.10
	Waglan Island	0.05	0.09
	Ko Lau Wan	0.07	0.11
	Chi Ma Wan	0.07	0.13
20	Quarry Bay/North Point	0.07	0.12
	Tai Po Kau	0.10	0.20
	Tsim Bei Tsui	0.09	0.17
	Tai O	0.06	0.12
	Waglan Island	0.06	0.11
	Ko Lau Wan	0.07	0.13
	Chi Ma Wan	0.08	0.15

Table 44 Storm Surge Increase Due to Climate Change (Con't)

Return Period (years)	Location	Storm Surge Increase (m)	
		Year 2050	Year 2090
50	Quarry Bay/North Point	0.08	0.14
	Tai Po Kau	0.13	0.25
	Tsim Bei Tsui	0.11	0.20
	Tai O	0.08	0.14
	Waglan Island	0.07	0.12
	Ko Lau Wan	0.09	0.15
	Chi Ma Wan	0.09	0.18
100	Quarry Bay/North Point	0.09	0.16
	Tai Po Kau	0.15	0.29
	Tsim Bei Tsui	0.12	0.23
	Tai O	0.09	0.16
	Waglan Island	0.08	0.13
	Ko Lau Wan	0.10	0.17
	Chi Ma Wan	0.10	0.20
200	Quarry Bay/North Point	0.10	0.18
	Tai Po Kau	0.17	0.34
	Tsim Bei Tsui	0.13	0.26
	Tai O	0.10	0.18
	Waglan Island	0.08	0.14
	Ko Lau Wan	0.11	0.19
	Chi Ma Wan	0.11	0.22

Table 45 Design Allowance to Enhance Climate Resilience

Return Period (years)	Location	Design Allowance (m)			
		Year 2050		Year 2090	
		$\Delta_{\text{sea level rise + storm surge increase}}$	$\Delta_{\text{wave effect}}$	$\Delta_{\text{sea level rise + storm surge increase}}$	$\Delta_{\text{wave effect}}$
100	Quarry Bay / North Point	0.05	0.06	0.24	0.18
	Tai Po Kau	0.09	0.03	0.31	0.08
	Tsim Bei Tsui	0.07	0.04	0.26	0.07
	Tai O	0.06	0.05	0.23	0.18
	Waglan Island	0.05	0.02	0.21	0.10
	Ko Lau Wan	0.05	0.04	0.24	0.10
	Chi Ma Wan	0.07	0.02	0.25	0.09
200	Quarry Bay / North Point	0.05	0.07	0.25	0.22
	Tai Po Kau	0.10	0.04	0.34	0.16
	Tsim Bei Tsui	0.07	0.04	0.27	0.11
	Tai O	0.06	0.08	0.24	0.26
	Waglan Island	0.05	0.04	0.21	0.14
	Ko Lau Wan	0.06	0.04	0.25	0.22
	Chi Ma Wan	0.08	0.08	0.25	0.23

Note The design allowance values for the 100 year return period above are calculated by considering the envelop of the (i) extreme wave condition and storm surge increase at 100-year return period and extreme water level at 10-year return period, (ii) extreme wave condition and storm surge increase at 10-year return period and extreme water level at 100-year return period, and (iii) extreme wave condition and storm surge increase at 50-year return period and extreme water level at 50-year return period.

The design allowance values for the 200 year return period above are calculated by considering the envelop of the (i) extreme wave condition and storm surge increase at 200-year return period and extreme water level at 10-year return period, (ii) extreme wave condition and storm surge increase at 10-year return period and extreme water level at 200-year return period, and (iii) extreme wave condition and storm surge increase at 100-year return period and extreme water level at 100-year return period.

The design allowance given above is for the design of new coastal structures with paved land behind. For the design of new coastal structures with unpaved land behind, which is not common in nature, designers are advised to add the figures of 0.01m and 0.05m for 2050 and 2090, respectively, to the design allowance given above.

Median projection values are adopted in the table.

Table 46 Increase in Design Extreme Sea Level due to Climate Change Effect in Year 2100 for 1 in 100 year return period

Return Period (years)	Location	Rise in Mean Sea Levels Due to Climate Change (m) (A)	Storm Surge Increase Due to Climate Change (m) (B)	Design Allowance to Enhance Climate Resilience (m) (C)		Total - Increase in Design Extreme Sea Level due to Climate Change Effect (m) (D) = (A) + (B) + (C)
				$\Delta_{\text{sea level rise}} + \Delta_{\text{storm surge increase}}$	$\Delta_{\text{wave effect}}$	
				(1 in 100 year return period)		
100	Quarry Bay/North Point	0.56	0.18	0.30	0.21	1.25
	Tai Po Kau	0.56	0.33	0.38	0.09	1.36
	Tsim Bei Tsui	0.56	0.26	0.32	0.08	1.22
	Tai O	0.56	0.18	0.29	0.21	1.24
	Waglan Island	0.56	0.14	0.27	0.12	1.09
	Ko Lau Wan	0.56	0.19	0.30	0.12	1.17
	Chi Ma Wan	0.56	0.23	0.31	0.11	1.21
	Average (Ranges of Values)		0.2 (0.1 to 0.3)	0.4 (0.4 to 0.5)		1.2 (1.1 to 1.4)

Notes:

- For $\Delta_{\text{storm surge increase}}$ and $\Delta_{\text{wave effect}}$, Year 2100's figures are linearly extrapolated based on the available projections in 2050 and 2090 in Tables 44 and 45, instead of being estimated based on robust scientific/engineering assessments. The designer shall consider the appropriateness of using the method of linear extrapolation case by case based on the uniqueness and site condition of the project. The $\Delta_{\text{sea level rise}}$ in Year 2100 can be estimated by referring to the projections of mean sea level rise in the Hong Kong Observatory's website.
- For simplicity, the table above is only for the purpose of illustrating the order of magnitude of increase in design extreme sea level due to climate change. For actual design of coastal structures, the designer shall in detail refer to the joint considerations of return periods of waves, storm surge increases and water levels required in section 5.10.2; and design life, nature and characteristics of the coastal structures required in sections 3.9 and 5.2.2 to adopt the appropriate figures.

FIGURES

LIST OF FIGURES

Figure No.		Page No.
1	Simplified Earth/Moon/Sun System for Spring and Neap Tides	145
2	Locations of Tide Stations	146
3	Locations of Weather Stations	147
4	Annual Wind Rose	148
5	General Shape of Wave Spectrum	149
6	Locations of Wave Stations	150
7	Wave Roses at Kau Yi Chau and West Lamma Channel Wave Stations	151
8	Locations of Offshore Wave Data from Storm Hindcasting	152
9	Wave Regions in the Harbour Area	153
10	Daily Wave Variation around a Harbour Wave Station close to Busy Fairways	154
11	Relationship between Design Life, Return Period and Probability of Exceedance	155
12	Ship Definitions	156
13	Schematic Diagram of Offshore Quaternary Stratigraphy of Hong Kong	157
14	Ground Water Profile behind Seawalls – Area Paved	158
15	Maximum Wave Pressure on Vertical Structures (Breaking and Non-Breaking Waves) – Pressure Distribution	159
16	Maximum Wave Pressure on Vertical Structures (Breaking and Non-Breaking Waves) – Alpha Values	160

	Page No.
17 Wave Pressure under Wave Trough	161
18 Wave Forces on Piles	162
19 Drag Coefficient Values for Circular Cylinders	163
20 Geometry of Vessel Approach to Berth	164
21 Hull and Fender Geometry at Impact	165

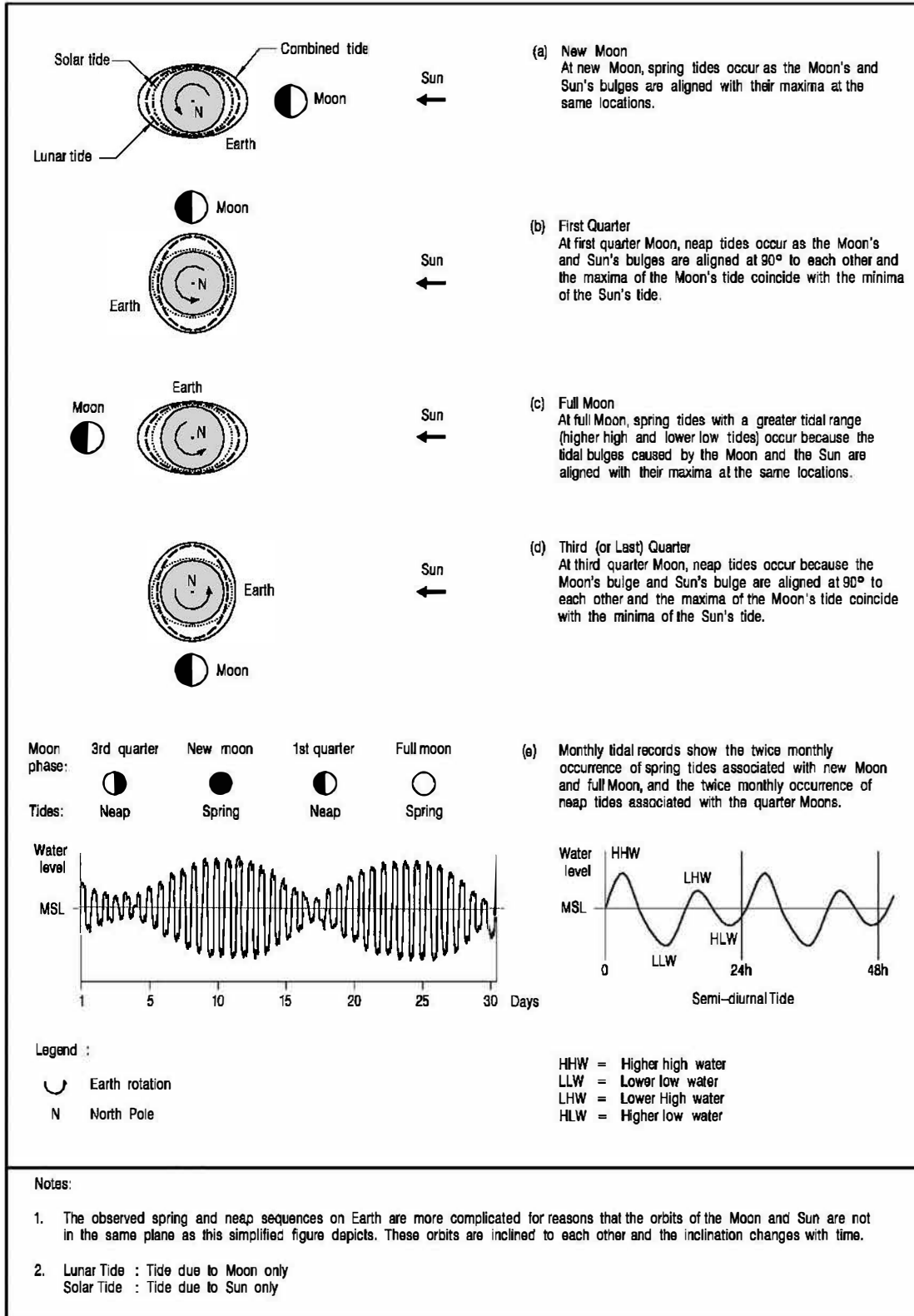

Figure 1 – Simplified Earth/Moon/Sun System for Spring and Neap Tides

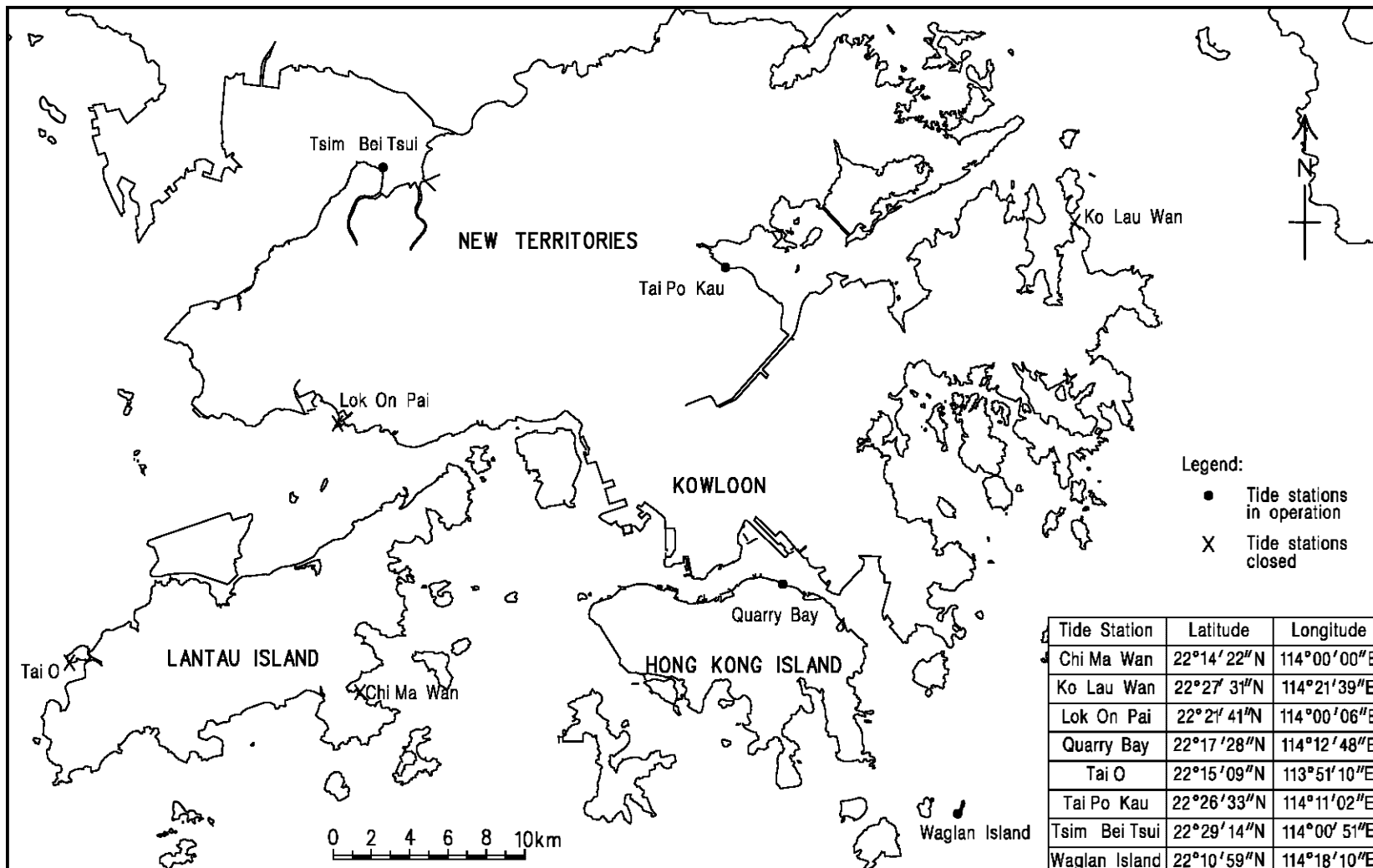

Figure 2 – Locations of Tide Stations

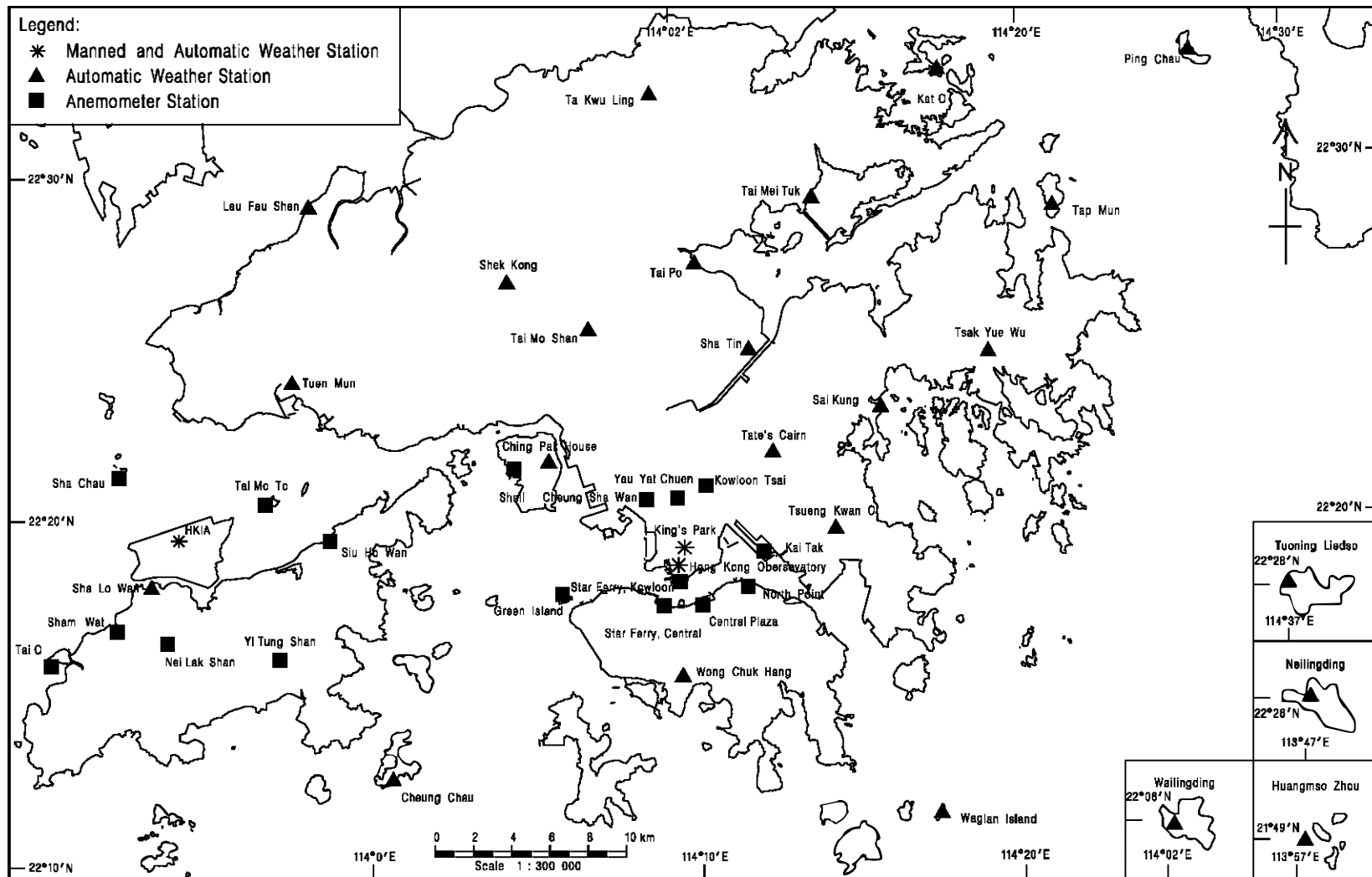

Figure 3 – Locations of Weather Stations

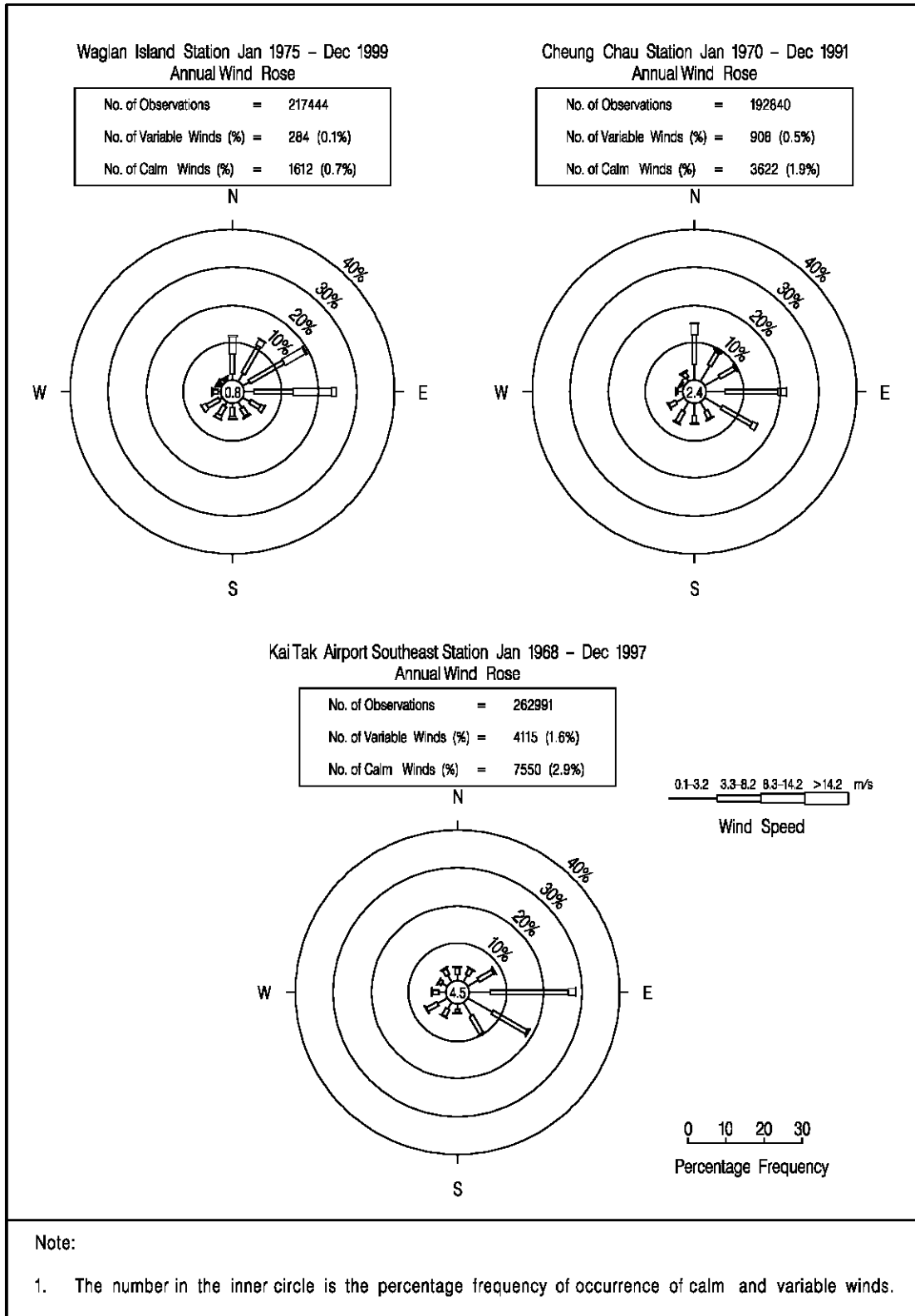

Figure 4 – Annual Wind Rose

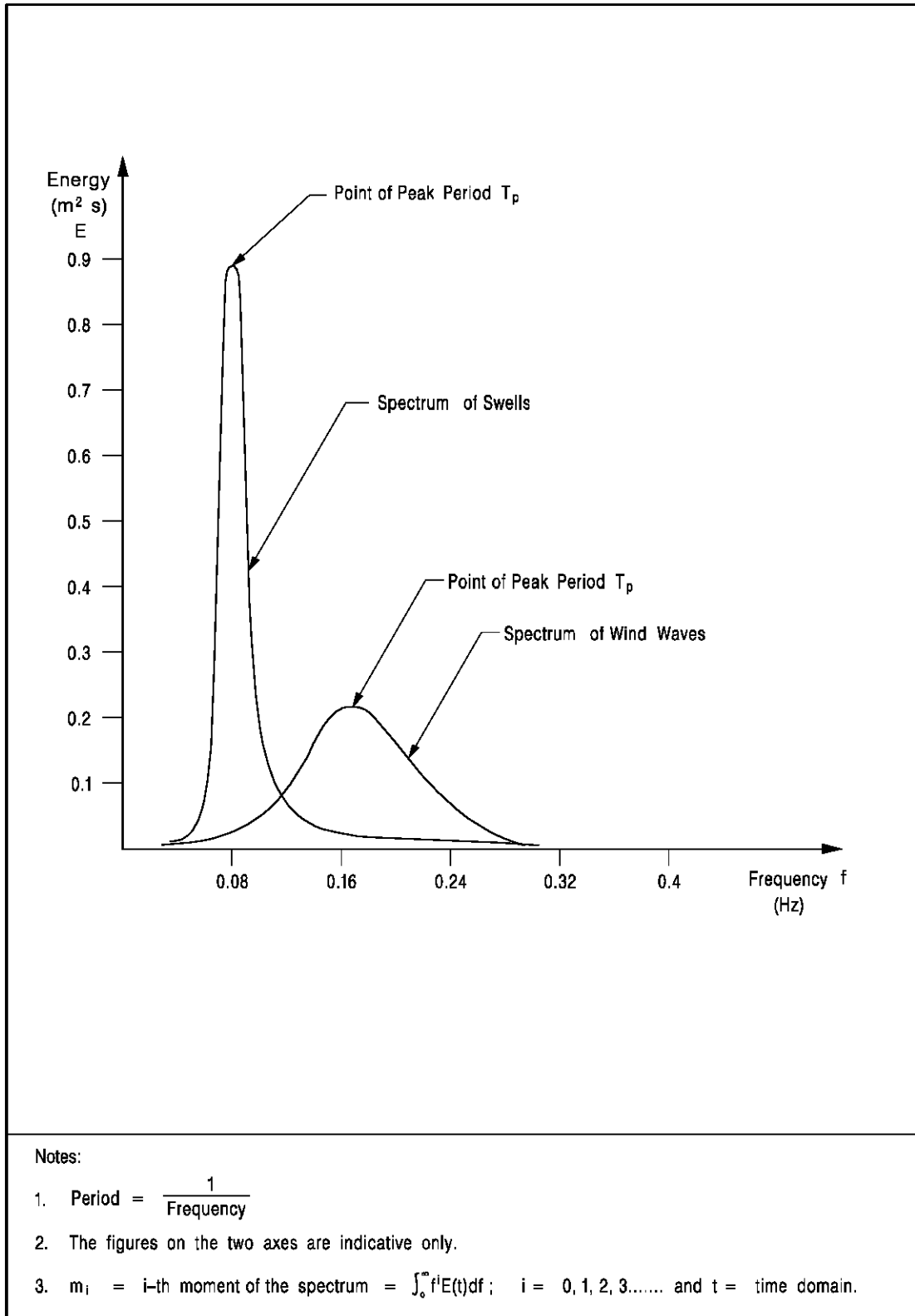

Figure 5 – General Shape of Wave Spectrum

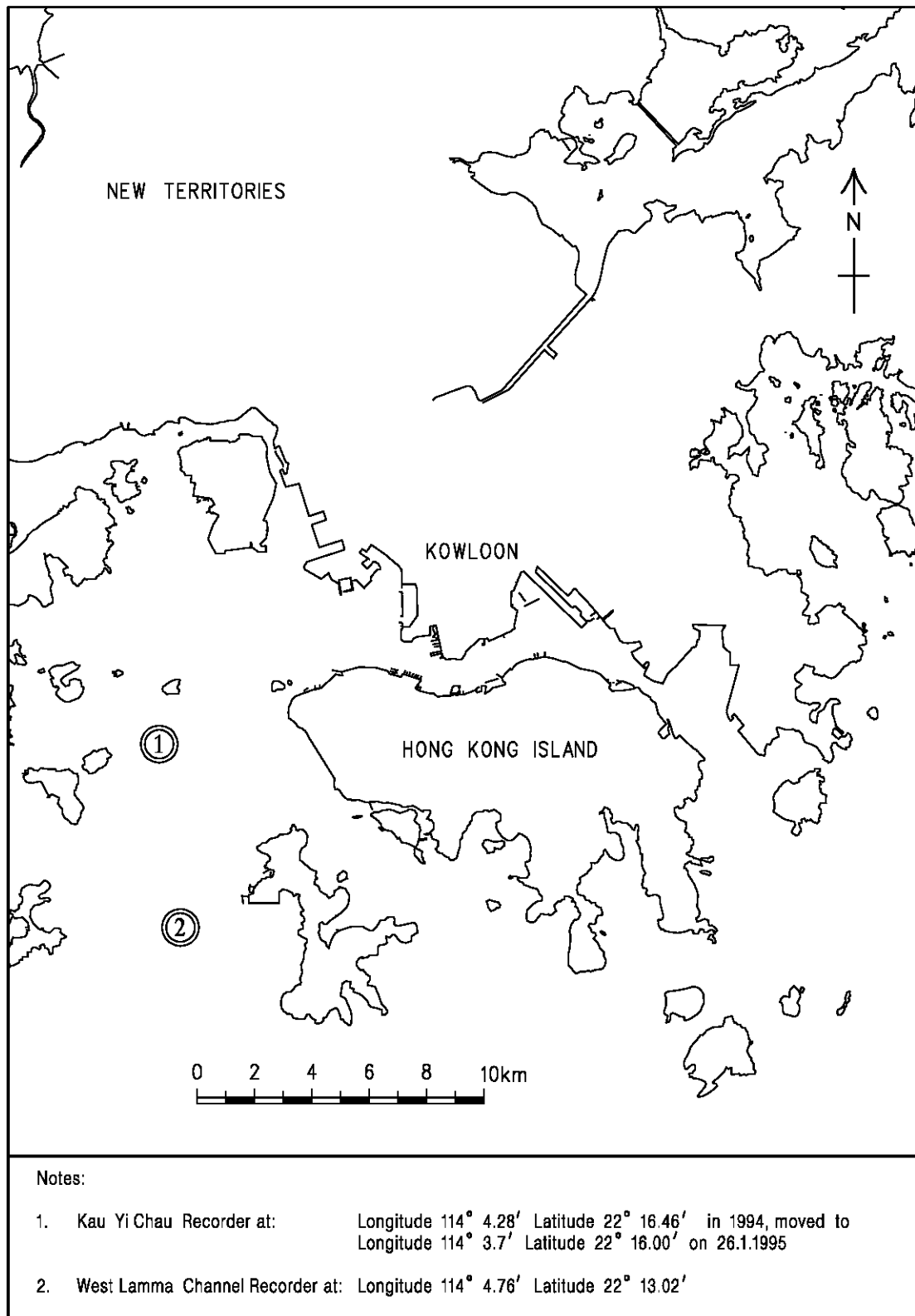

Figure 6 – Locations of Wave Stations

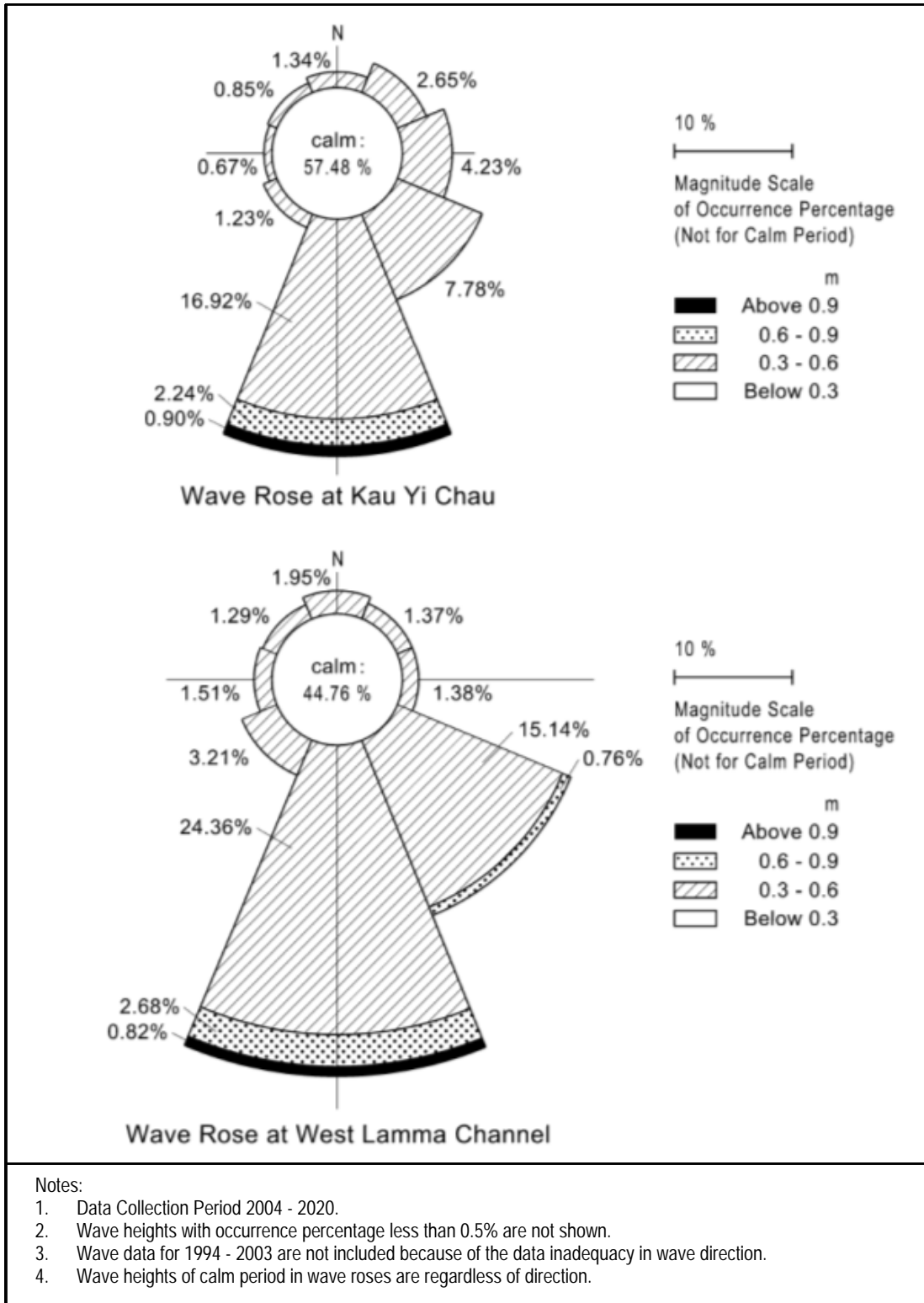

Figure 7 – Wave Roses at Kau Yi Chau and West Lamma Channel Wave Stations

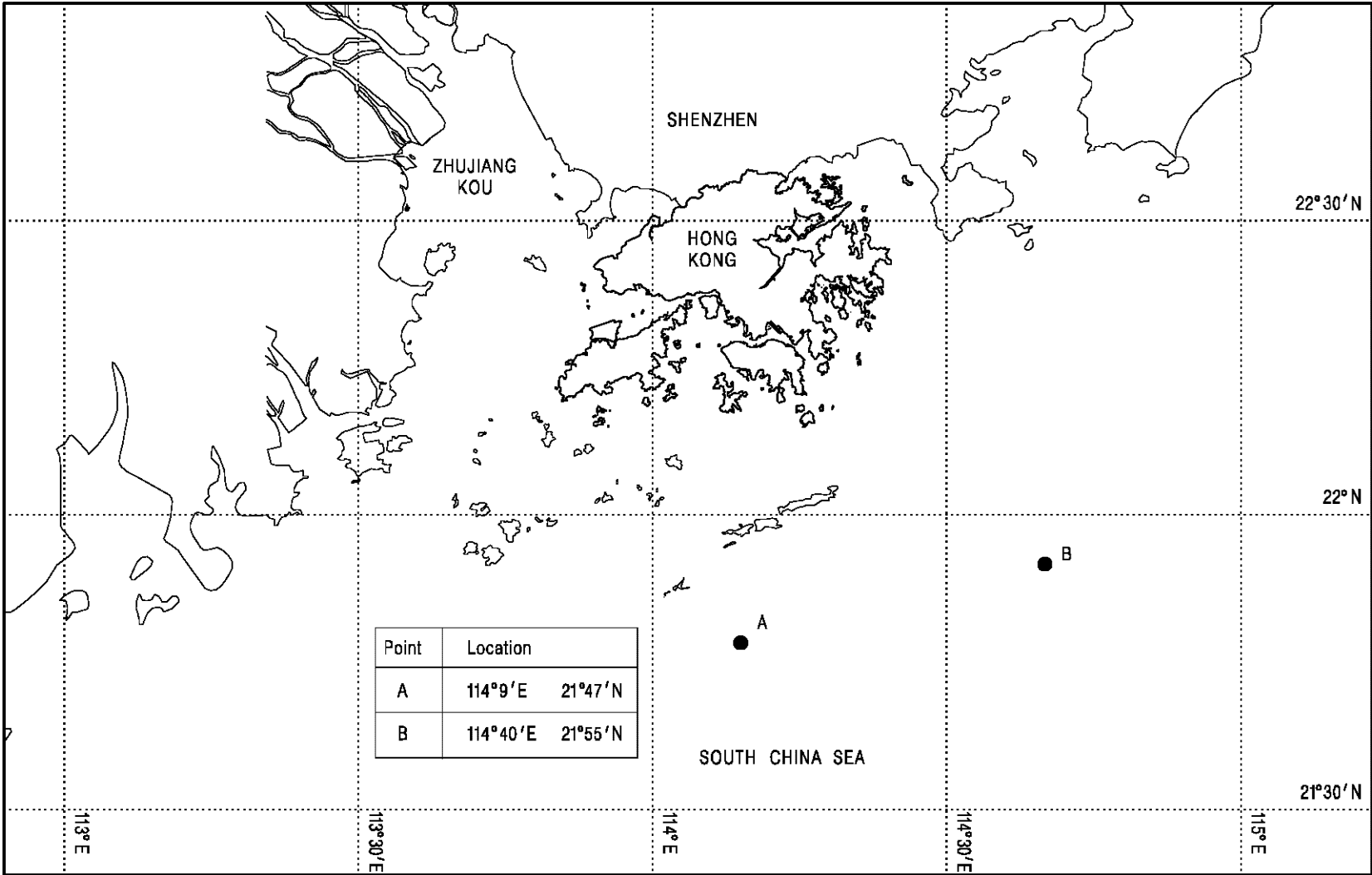

Figure 8 – Locations of Offshore Wave Data from Storm Hindcasting

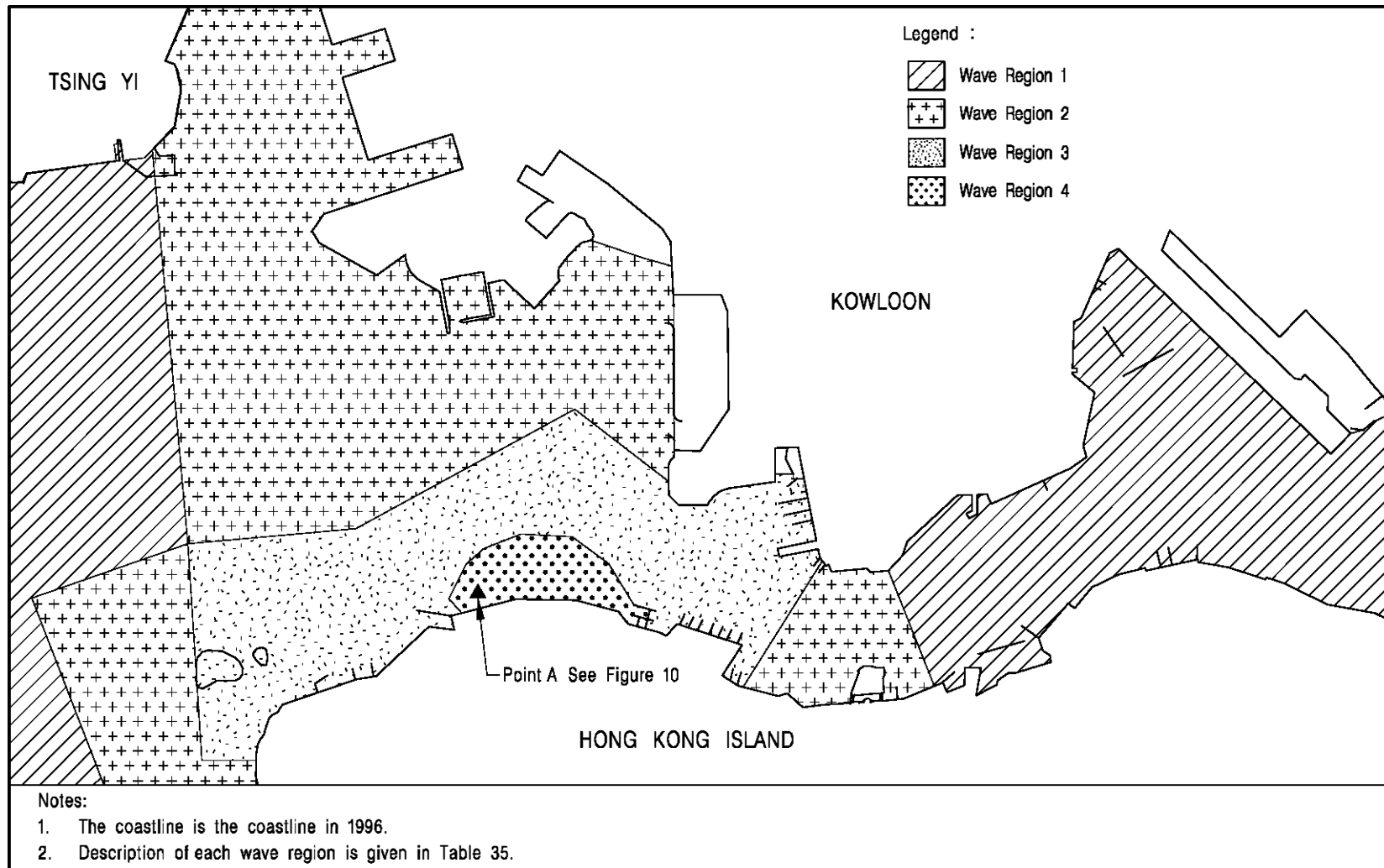

Figure 9 – Wave Regions in the Harbour Area

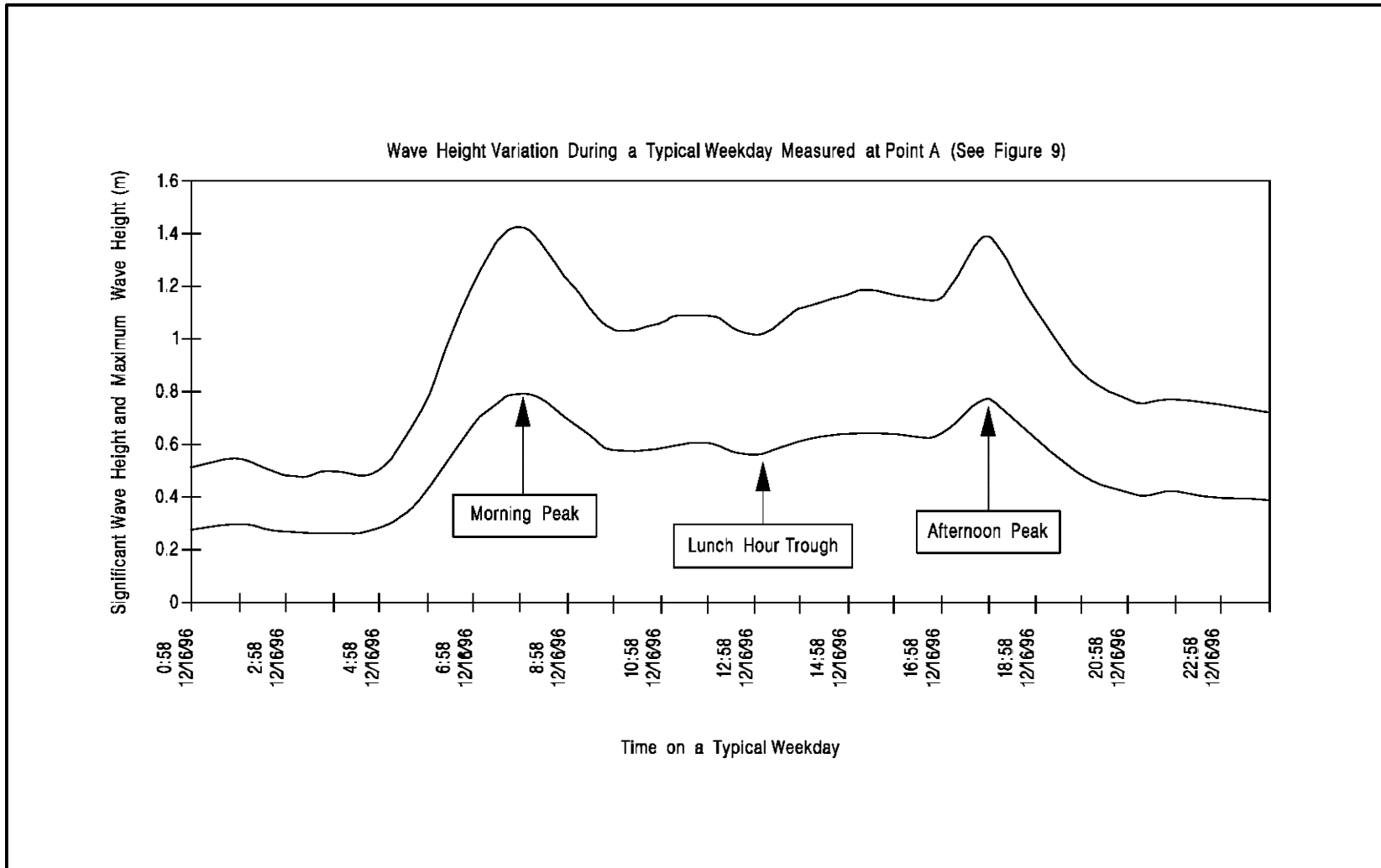

Figure 10 – Daily Wave Variation around a Harbour Wave Station close to Busy Fairways

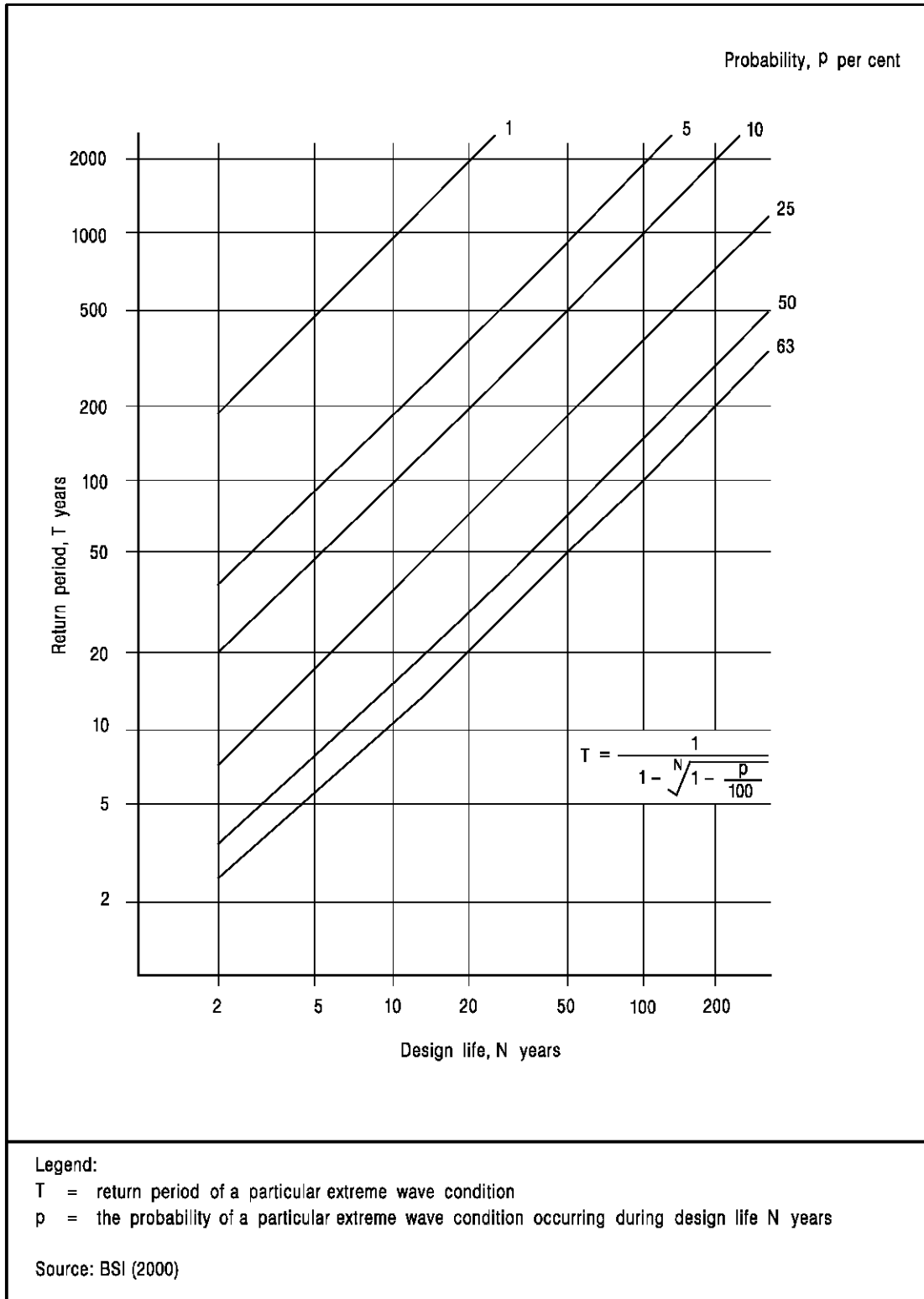

Figure 11 – Relationship between Design Life, Return Period and Probability of Exceedence

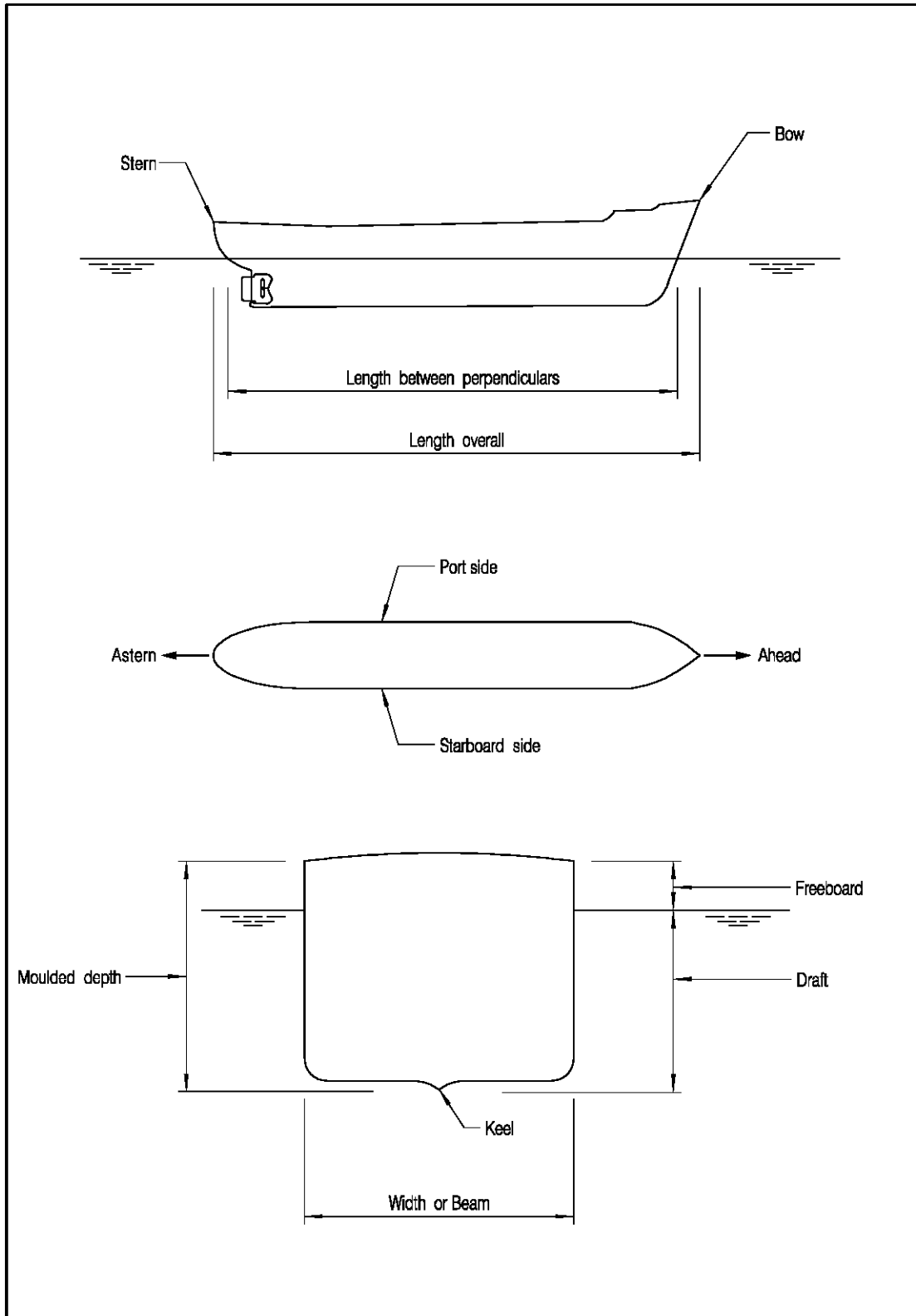

Figure 12 – Ship Definitions

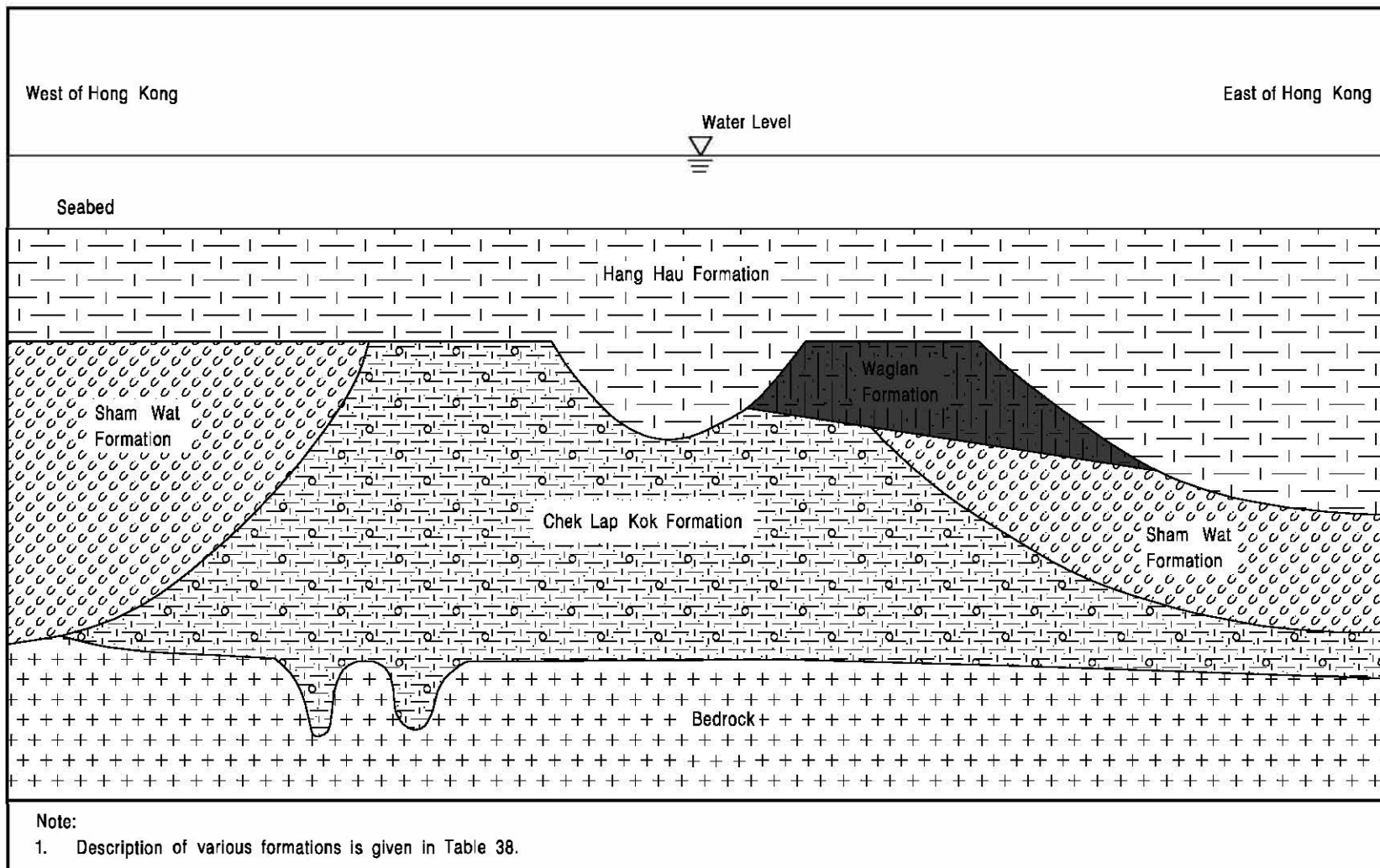

Figure 13 – Schematic Diagram of Offshore Quaternary Stratigraphy of Hong Kong

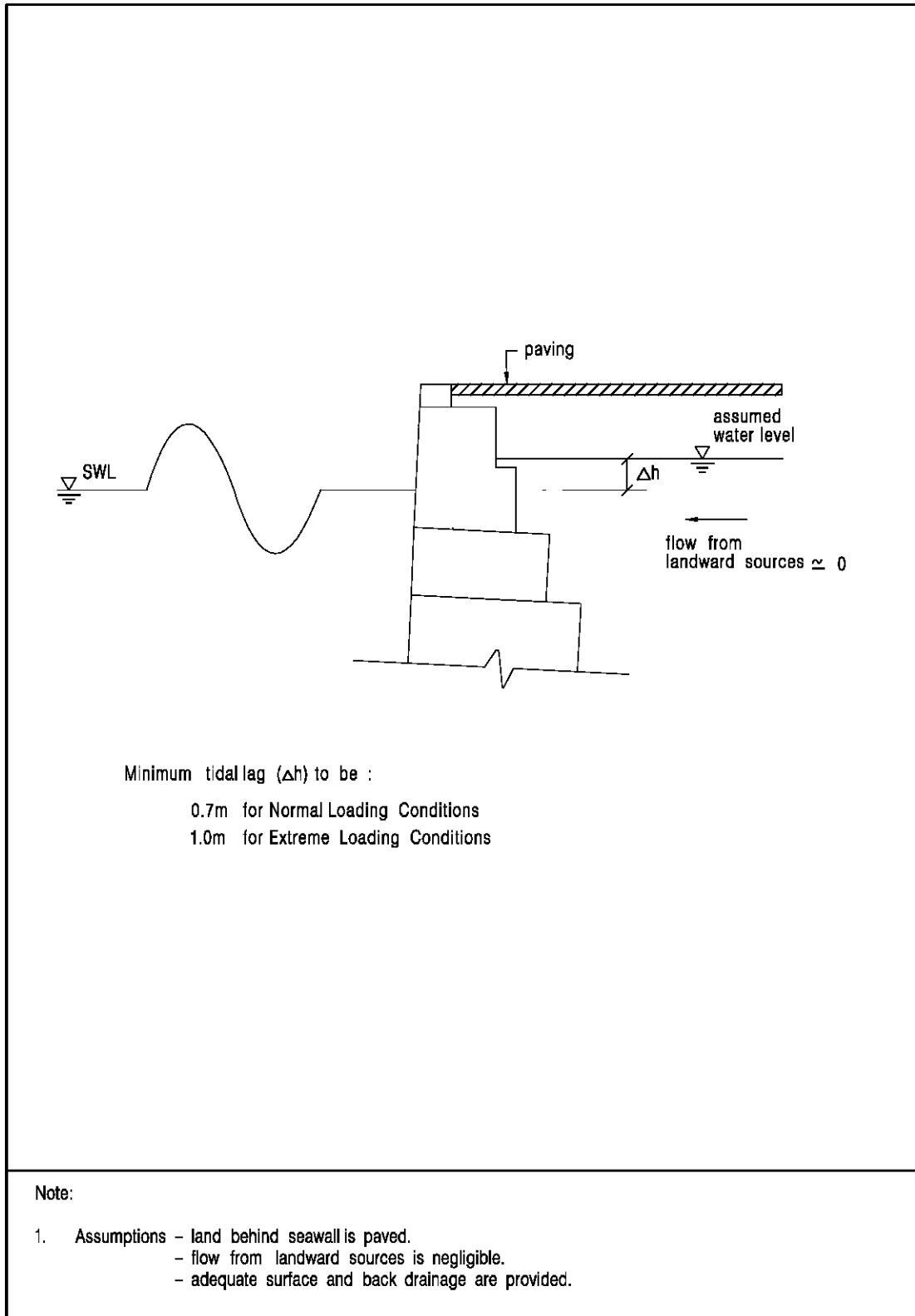
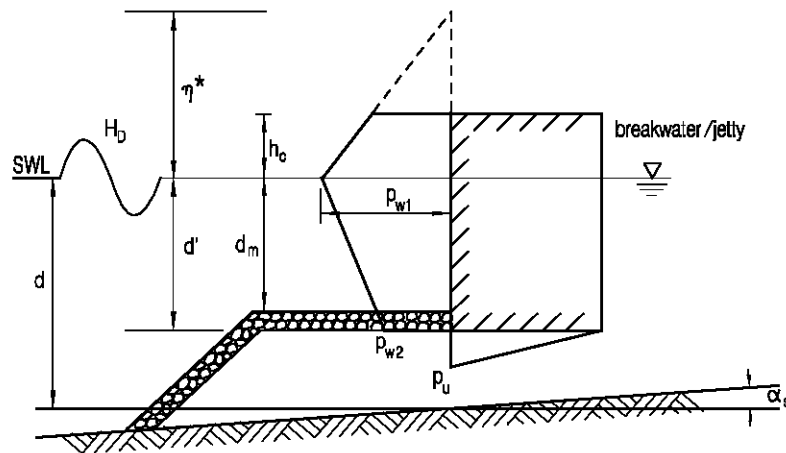

Figure 14 – Ground Water Profile behind Seawalls – Area Paved



(hydrostatic pressure and buoyancy not shown)

The elevation to which wave pressure is exerted :

$$\eta^* = 0.75 (1 + \cos \beta) H_D$$

Where β is the nominal angle between the direction of wave approach and a line normal to the structure. When the actual angle between the direction of approach and the normal is 15° or less, $\beta = 0$. When the actual angle exceeds 15° , $\beta = \text{actual angle of } 15^\circ$

Wave pressure on the front face of the structure (Hydrostatic pressure not included) :

$$p_{w1} = \frac{1}{2} (1 + \cos \beta) (\alpha_1 + \alpha_2 \cos^2 \beta) \gamma_w H_D$$

$$p_{w2} = \alpha_3 p_{w1}$$

Uplift pressure at the toe of the structure (buoyancy not included) :

$$p_u = \frac{1}{2} \alpha_1 \alpha_3 (1 + \cos \beta) \gamma_w H_D$$

where

$$\alpha_1 = 0.6 + \frac{1}{2} \left[\frac{4\pi d / L}{\sinh(4\pi d / L)} \right]^2$$

$$\alpha_2 \text{ is the lesser of } \frac{1}{3} \left(\frac{d_b - d_m}{d_b} \right) \left(\frac{H_D}{d_m} \right)^2 \text{ or } \alpha_2 = \frac{2 d_m}{H_D}$$

$$\alpha_3 = 1 - \frac{d'}{d} \left(1 - \frac{1}{\cosh(2\pi d / L)} \right)$$

Note:

1. α_1, α_2 and α_3 may also be estimated from design curves in Figure 16

Source: BSI (2000)

Figure 15 – Maximum Wave Pressure on Vertical Structures (Breaking and Non-breaking Waves) – Pressure Distribution

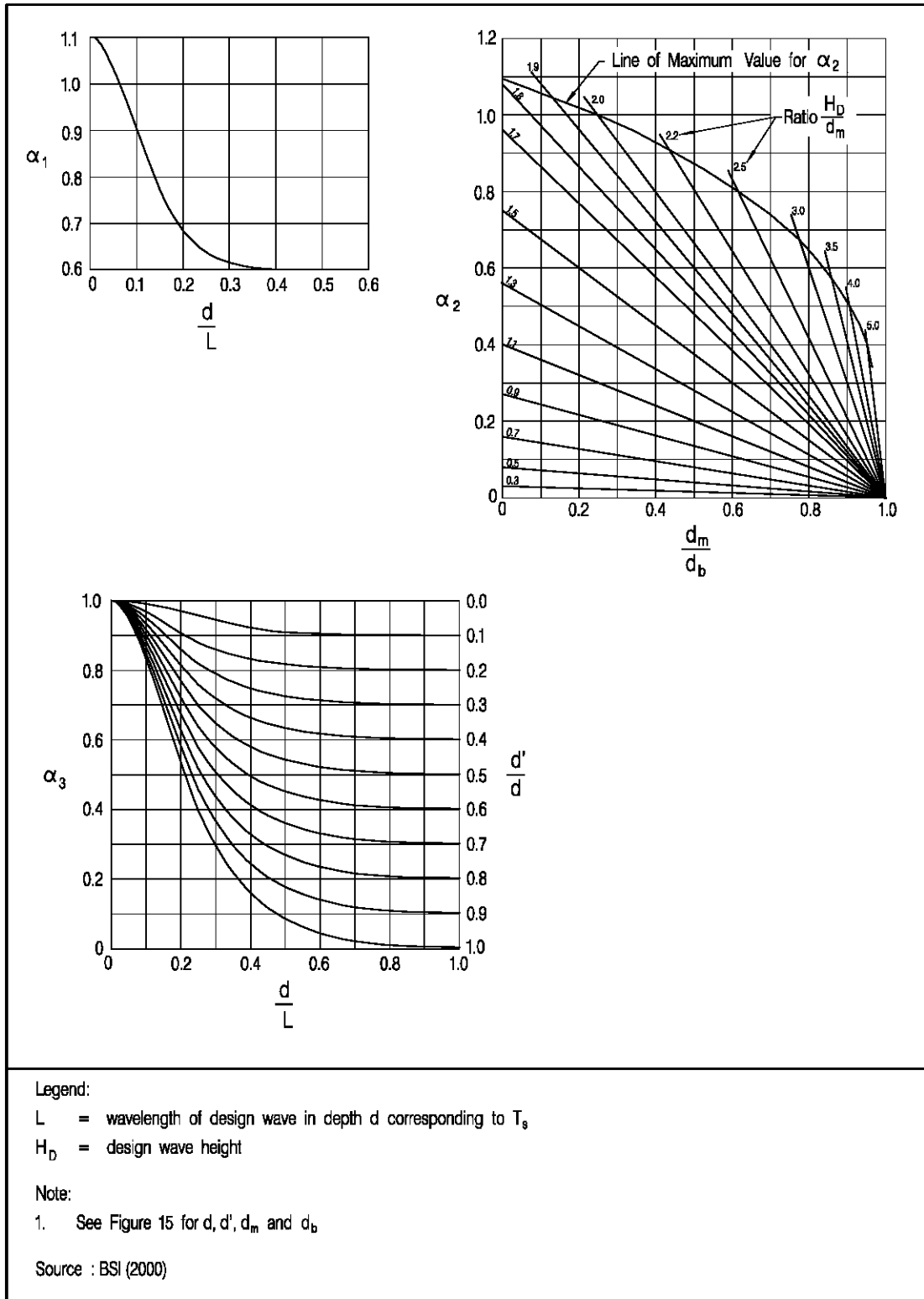

Figure 16 – Maximum Wave Pressure on Vertical Structures (Breaking and Non-breaking Waves) – Alpha Values

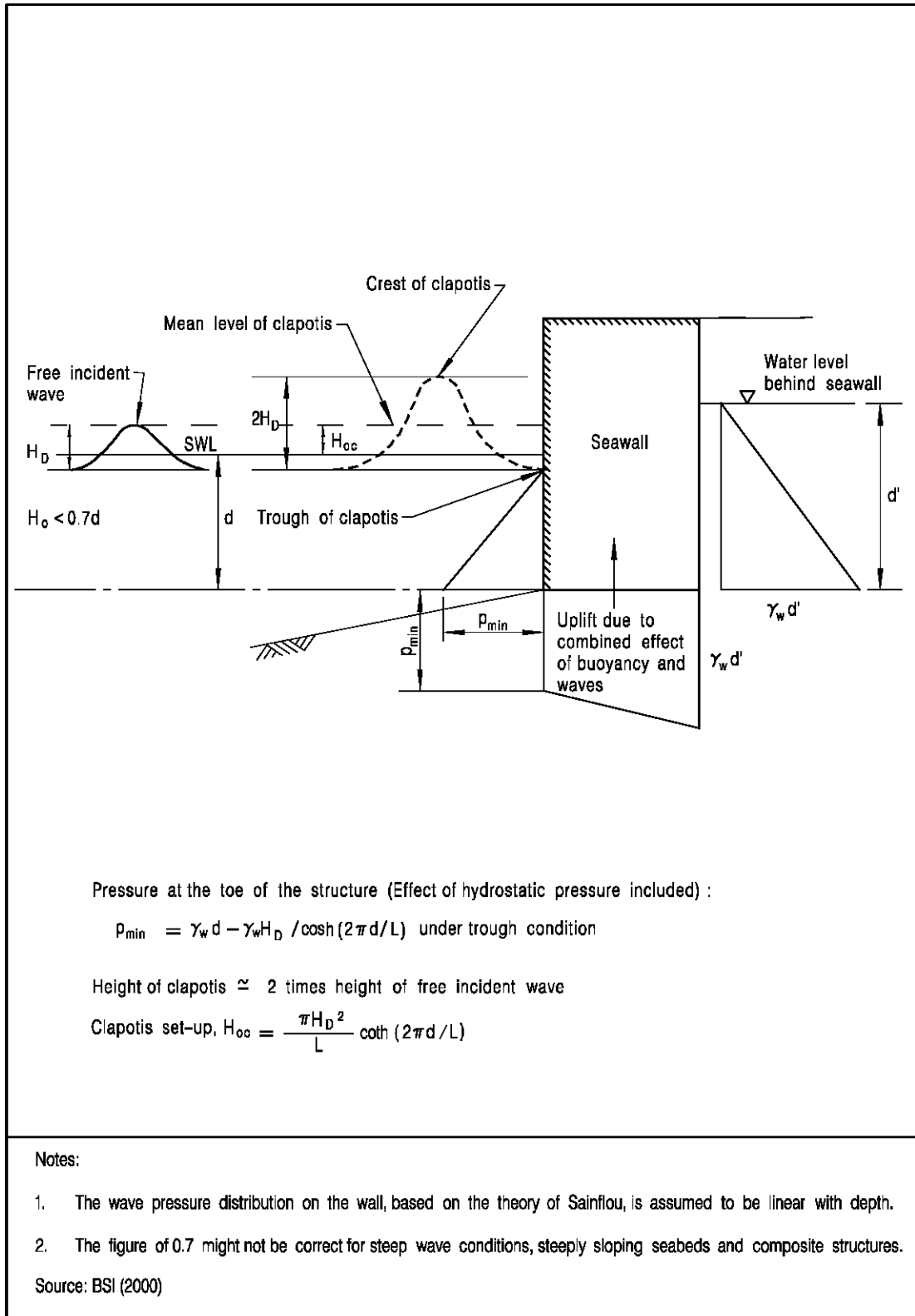

Figure 17 – Wave Pressure under Wave Trough

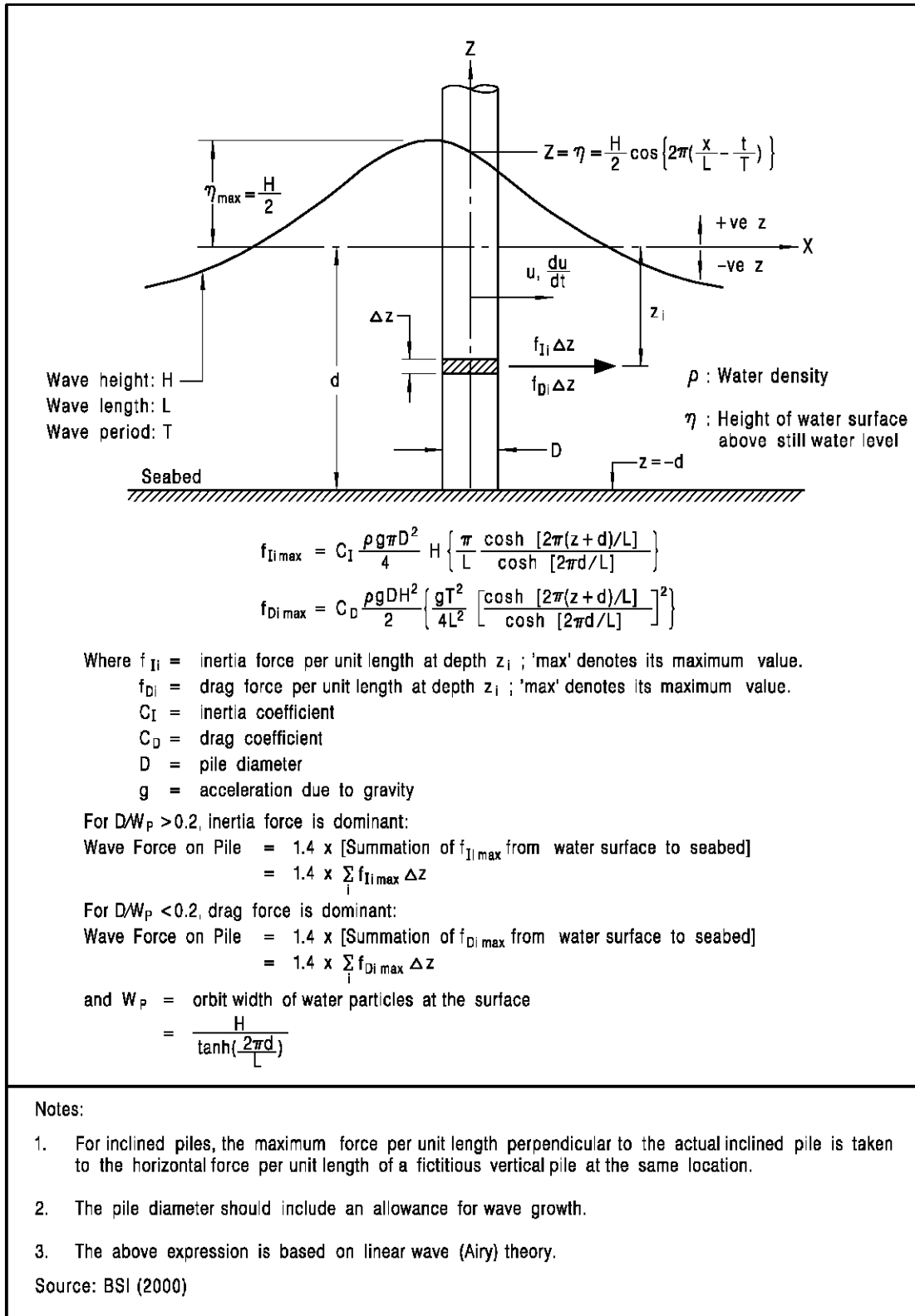
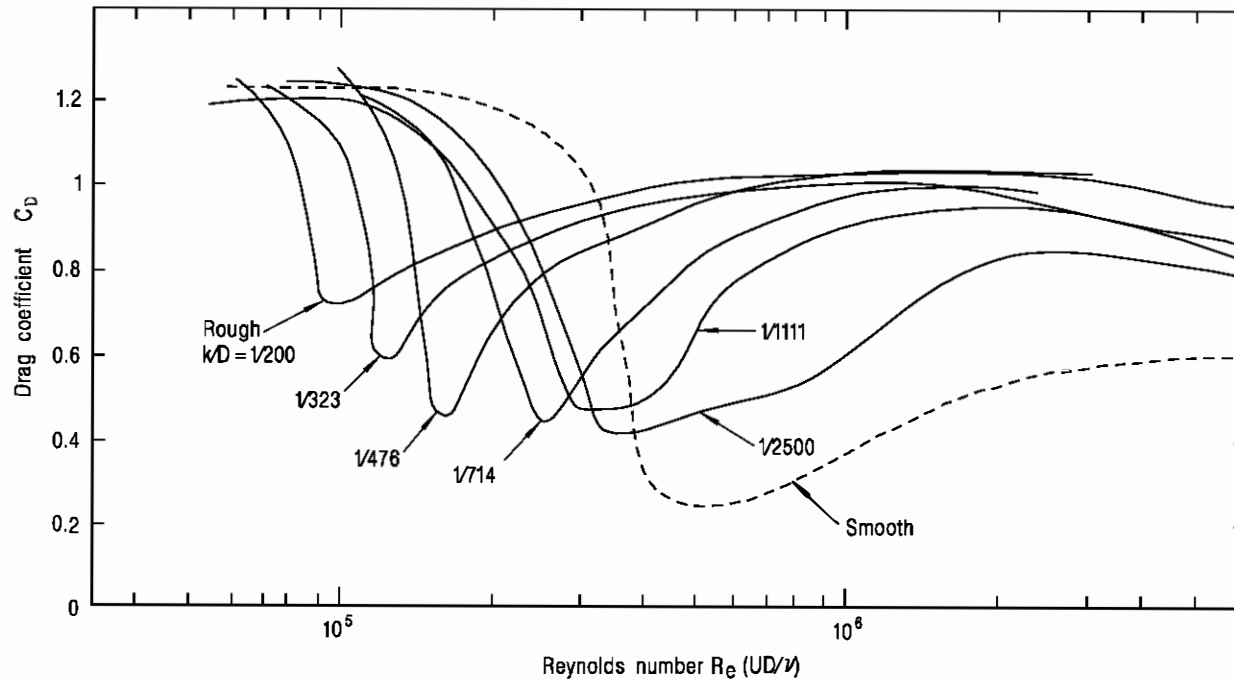

Figure 18 – Wave Forces on Piles



Legend:

- D = Diameter of cylinder/pile
- U = Velocity normal to member
- ν = Kinematic viscosity of water
- k = Roughness

Source : BSI(2000)

Figure 19 – Drag Coefficient Values for Circular Cylinders

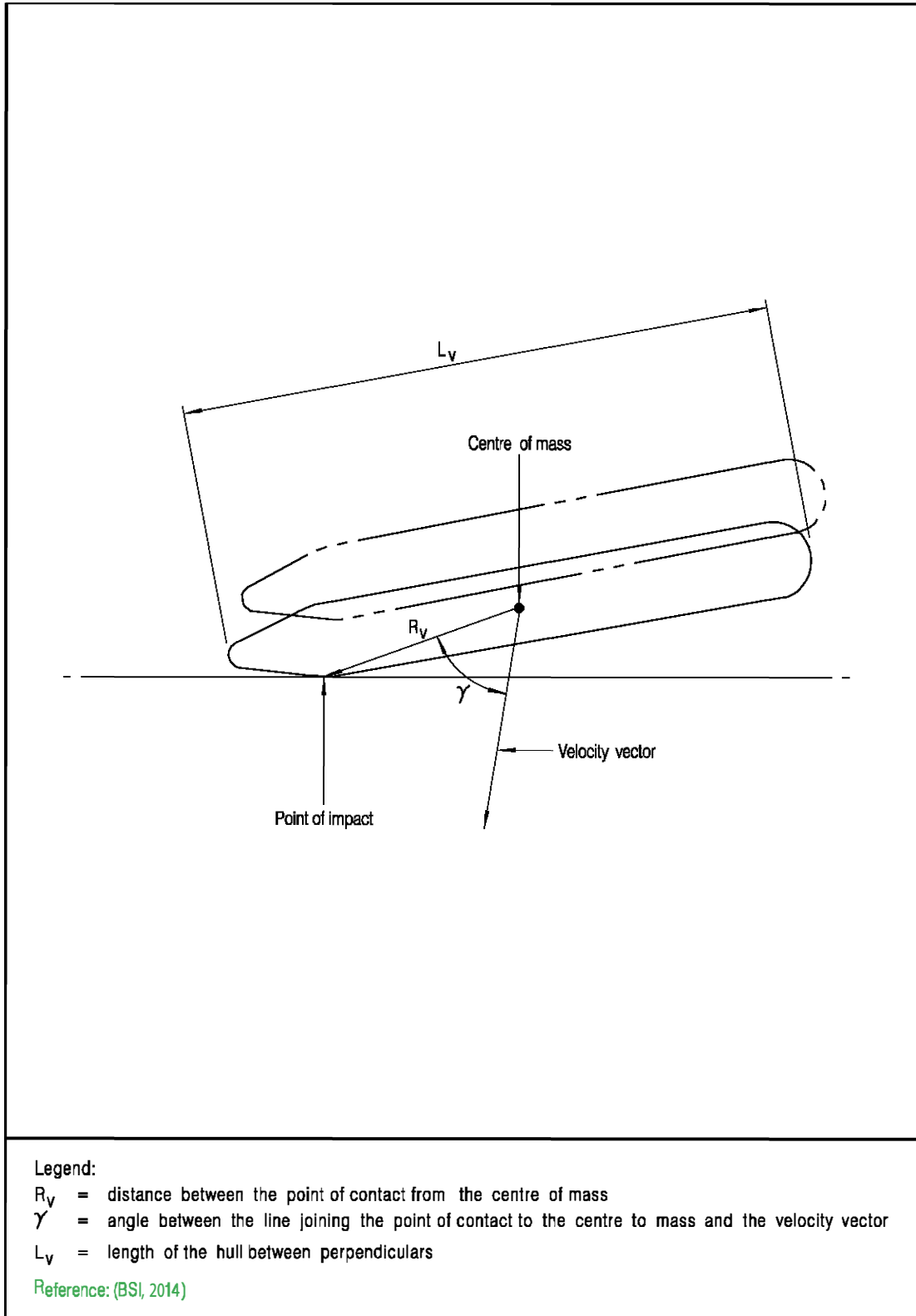

Figure 20 – Geometry of Vessel Approach to Berth

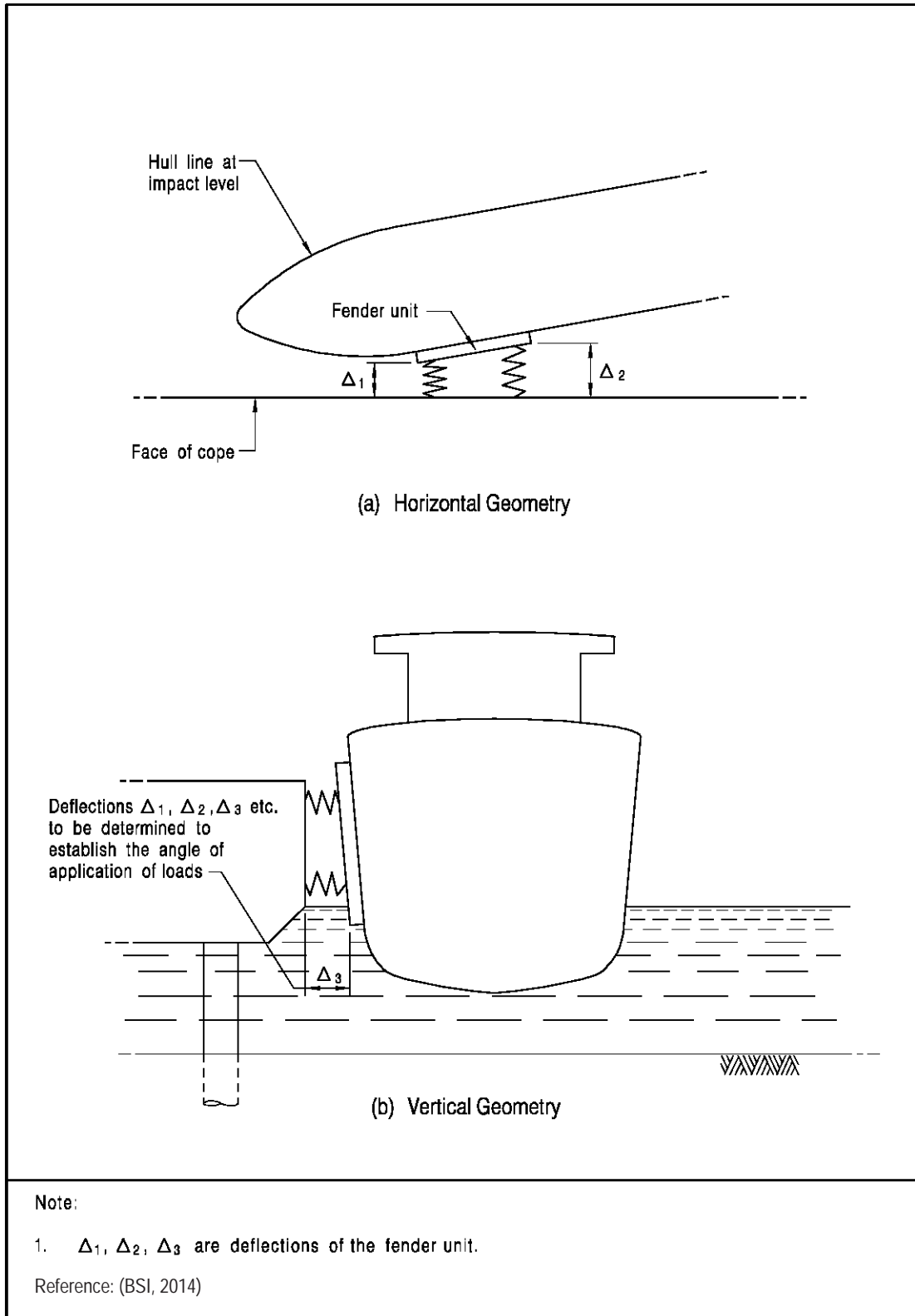

Figure 21 – Hull and Fender Geometry at Impact

APPENDIX A

ESTIMATION OF WAVE HEIGHT IN SURF ZONE

CONTENTS

	Page No.
TITLE PAGE	167
CONTENTS	169
A.1 GENERAL	171
A.2 EQUIVALENT DEEPWATER SIGNIFICANT WAVE HEIGHT	171
A.3 REGION OF BREAKING WAVES	172
A.4 WAVE HEIGHT IN SURF ZONE	172
A.5 REFERENCES	174
LIST OF FIGURES	175

A.1 GENERAL

This Appendix describes a method of estimating the wave height for random wave breaking in surf zone developed by Goda. For more details of wave breaking, reference should be made to Goda (2000) and BS 6349:Part 1 (BSI, 2000).

A.2 EQUIVALENT DEEPWATER SIGNIFICANT WAVE HEIGHT

The analysis of wave transformation is often facilitated by the concept of equivalent deepwater wave. It is a hypothetical wave devised to account for the effects of refraction, diffraction and bottom friction on the deepwater wave. This device is useful for physical model tests using wave flumes of uniform width, which have difficulty in reproducing the complicated real seabed. Using the equivalent significant deepwater wave height to cater for these processes, model tests can be carried out with straight and parallel seabed contours.

The equivalent deepwater significant wave height is related to the deepwater significant wave height as follows and is used in the Goda's method of wave breaking :

$$H_o' = K_r * K_f * K_d * H_o$$

Where H_o' is the equivalent deepwater significant wave height.

H_o is the deepwater significant wave height.

K_r is the coefficient of random wave refraction.

K_f is the coefficient of random wave attenuation due to bottom friction.

K_d is the coefficient of random wave diffraction.

The above formula implies that the deepwater wave height is adjusted to account for the change due to wave refraction, diffraction and attenuation due to bottom friction. The effect of shoaling is not included in the evaluation of H_o' .

The period of the equivalent deepwater wave is generally regarded as being equal to the deepwater significant wave period, but in reality the significant wave period may vary during wave propagation, as in the sheltered area behind a breakwater.

A.3 REGION OF BREAKING WAVES

Goda has developed design chart which relates the shoaling coefficient with the equivalent deepwater steepness, the slope of seabed and the relative water depth as shown in Figure A1. The figure presents the shoaling coefficient including the finite amplitude effect during wave propagation toward the shore. The shoaling coefficient given in the upper right corner of the figure corresponds to water of relative depth d/L_o greater than 0.09 (d : water depth, L_o : deepwater wavelength) and is the same as the value of the shoaling coefficient for small amplitude waves. L_o may be estimated from the following formula :

$$L_o = \frac{gT^2}{2\pi} = 1.56T^2$$

The dotted lines in the figure for the seabed slope demarcate the regions of wave breaking and non-breaking. When the intersecting point of the relative water depth (d/L_o) and equivalent deepwater steepness (H_o'/L_o) falls in the region of the dotted lines, the structure will be subject to the action of breaking waves.

Where the wave height (at a certain water depth outside the surf zone) computed from a mathematical wave model has included the effect of shoaling, refraction, diffraction and bottom friction, the equivalent deepwater wave height H_o' may be approximately determined by dividing the computed wave height by the shoaling coefficient at that water depth outside the surf zone shown in the upper right corner of Figure A1.

A.4 WAVE HEIGHT IN SURF ZONE

The variation of wave height within the surf zone can be estimated from the following formulae derived by Goda :

$$\text{If } d/L_o \geq 0.2, \quad (1) \quad H_{1/3} = K_s H_o'$$

$$(2) \quad H_{\max} = 1.8K_s H_o'$$

$$\text{If } d/L_o < 0.2, \quad (1) \quad H_{1/3} \text{ is the minimum of the following :}$$

- $H_{1/3} = \lambda_o H_o' + \lambda_1 d$ *or*
- $H_{1/3} = \lambda_{\max} H_o'$ *or*
- $H_{1/3} = K_s H_o'$

(2) H_{\max} is the minimum of the following :

- $H_{\max} = \beta_o H_o' + \beta_1 d$ or
- $H_{\max} = \beta_{\max} H_o'$ or
- $H_{\max} = 1.8K_s H_o'$

The coefficients λ_o , λ_1 , λ_{\max} , β_o , β_1 and β_{\max} are given by the following expressions :

$$\begin{aligned} \text{Coefficients for } H_{1/3} : \quad & \lambda_o = 0.028(H_o'/L_o)^{-0.38} \exp(20 \tan^{1.5} \theta) \\ & \lambda_1 = 0.52 \exp(4.2 \tan \theta) \\ & \lambda_{\max} = \max \{0.92, 0.32(H_o'/L_o)^{-0.29} \exp(2.4 \tan \theta)\} \end{aligned}$$

$$\begin{aligned} \text{Coefficients for } H_{\max} : \quad & \beta_o = 0.052(H_o'/L_o)^{-0.38} \exp(20 \tan^{1.5} \theta) \\ & \beta_1 = 0.63 \exp(3.8 \tan \theta) \\ & \beta_{\max} = \max \{1.65, 0.53(H_o'/L_o)^{-0.29} \exp(2.4 \tan \theta)\} \end{aligned}$$

where θ denotes the slope of the seabed.

$\max \{a, b\}$ denotes the larger value of a or b.

exp represents the exponential function.

Alternatively, the wave heights may be estimated from the charts in Figure A2 for bottom slopes of 1/10, 1/20, 1/30 and 1/100. Each chart contains a dash-dot curve labelled "Attenuation less than 2%". In the zone to the right of this curve, the attenuation in wave height due to wave breaking is less than 2% and the wave height can be estimated from the shoaling coefficient given in Figure A1.

The formulae can give estimated wave heights differing by several percent from those obtained from the graphs. In particular for waves of greater gradient than 0.04 in the water depth where $\lambda_o H_o' + \lambda_1 d = \lambda_{\max} H_o'$, differences can exceed 10% with a similar difference for H_{\max} . There can also be a discontinuity in H_{\max} at $d/L_o = 0.2$.

It should be noted that it may be safer to use the wave height at the depth of about $0.5H_o'$ for structures located in the shoreline area with water depth shallower than such depth for estimation of wave force and action on the structures.

A.5 REFERENCES

BSI (2000). Maritime Structures – Part 1 : Code of Practice for General Criteria (BS 6349-1:2000). British Standards Institution, London, 189p.

Goda Y. (2000). Random Seas and Design of Maritime Structures (2nd Edition). World Scientific Publishing Co. Pte. Ltd, 443p.

LIST OF FIGURES

Figure No.		Page No.
A1	Diagram of Nonlinear Wave Shoaling	177
A2	Estimation of Wave Height in the Surf Zone (4 Sheets)	178

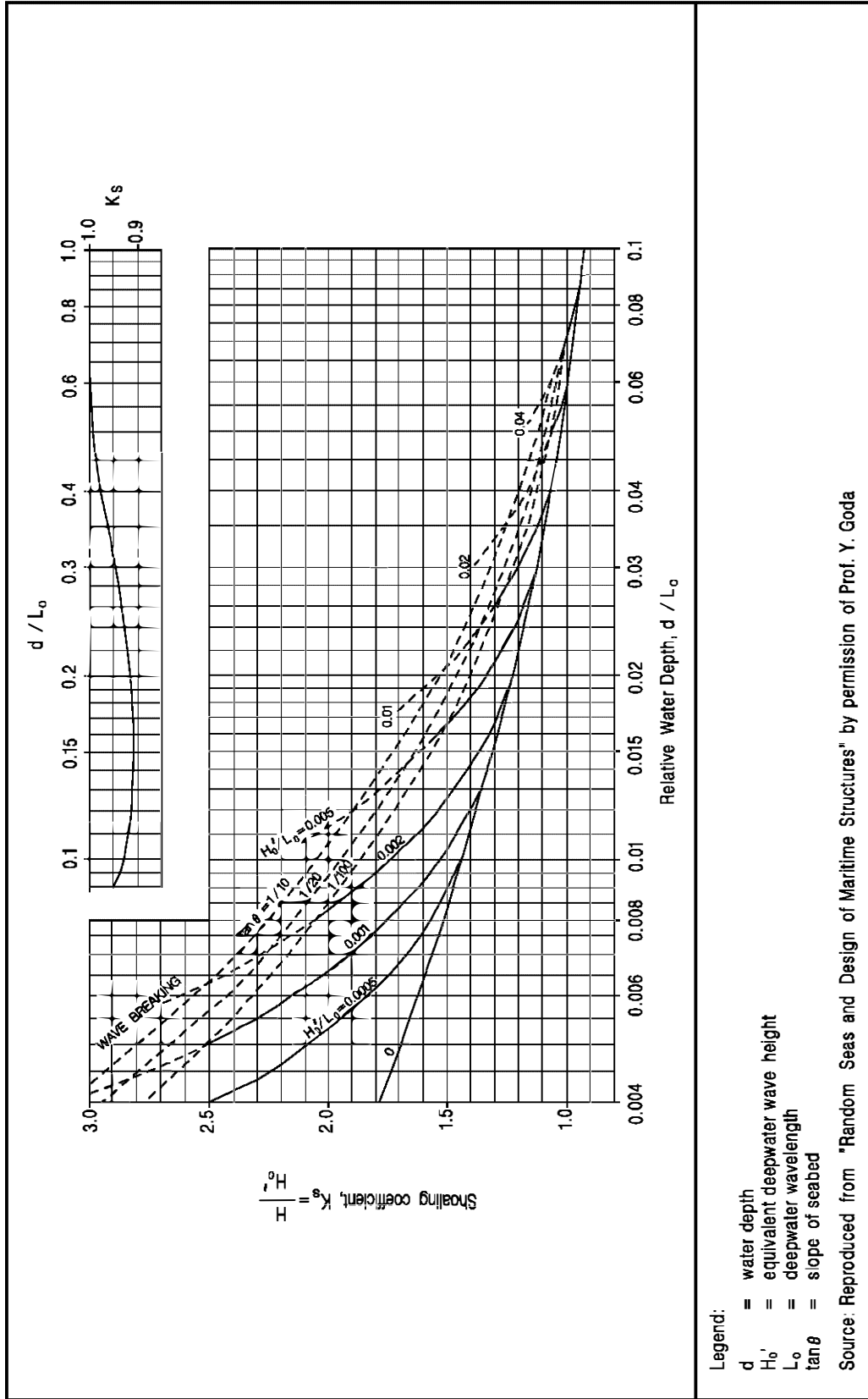
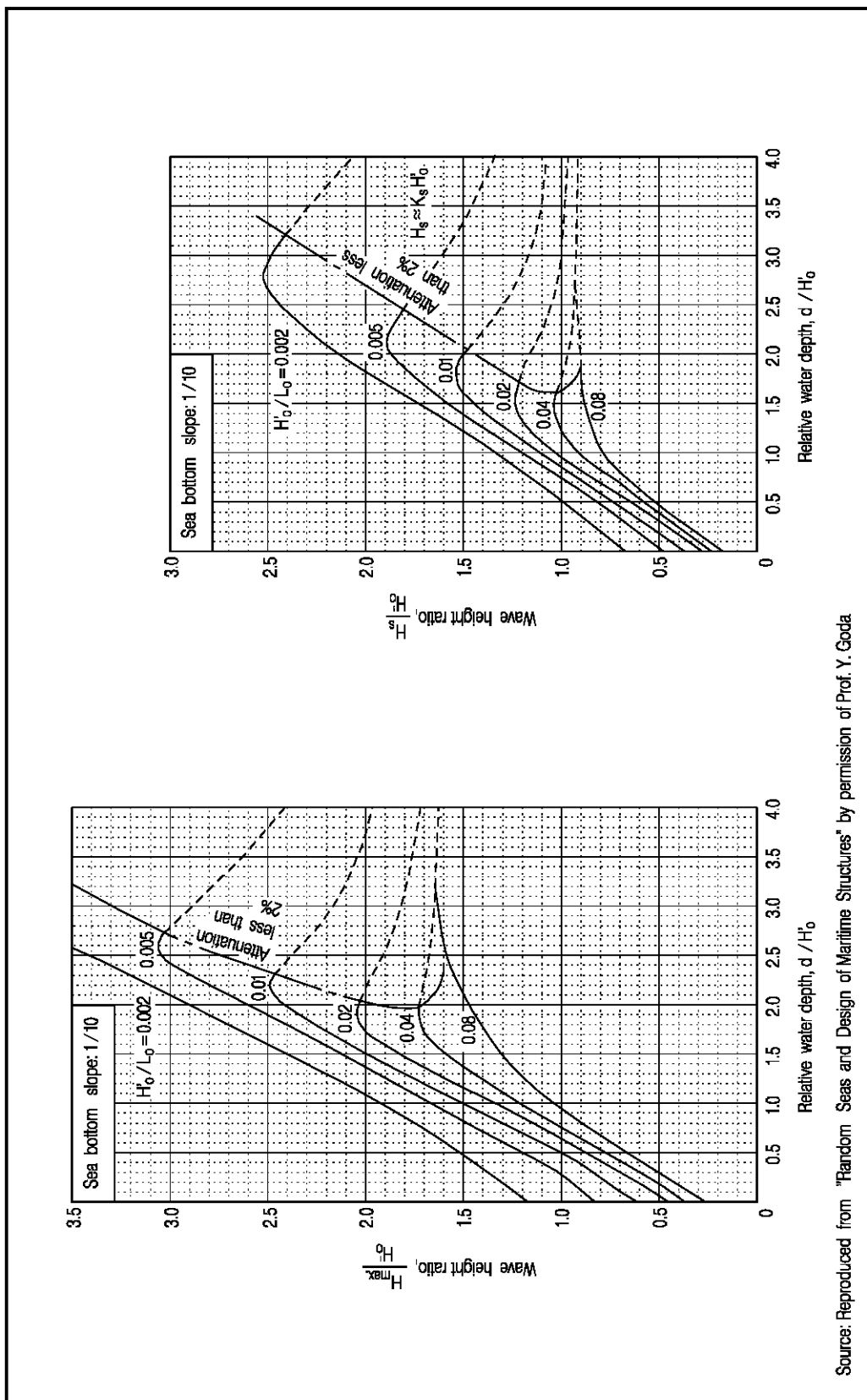
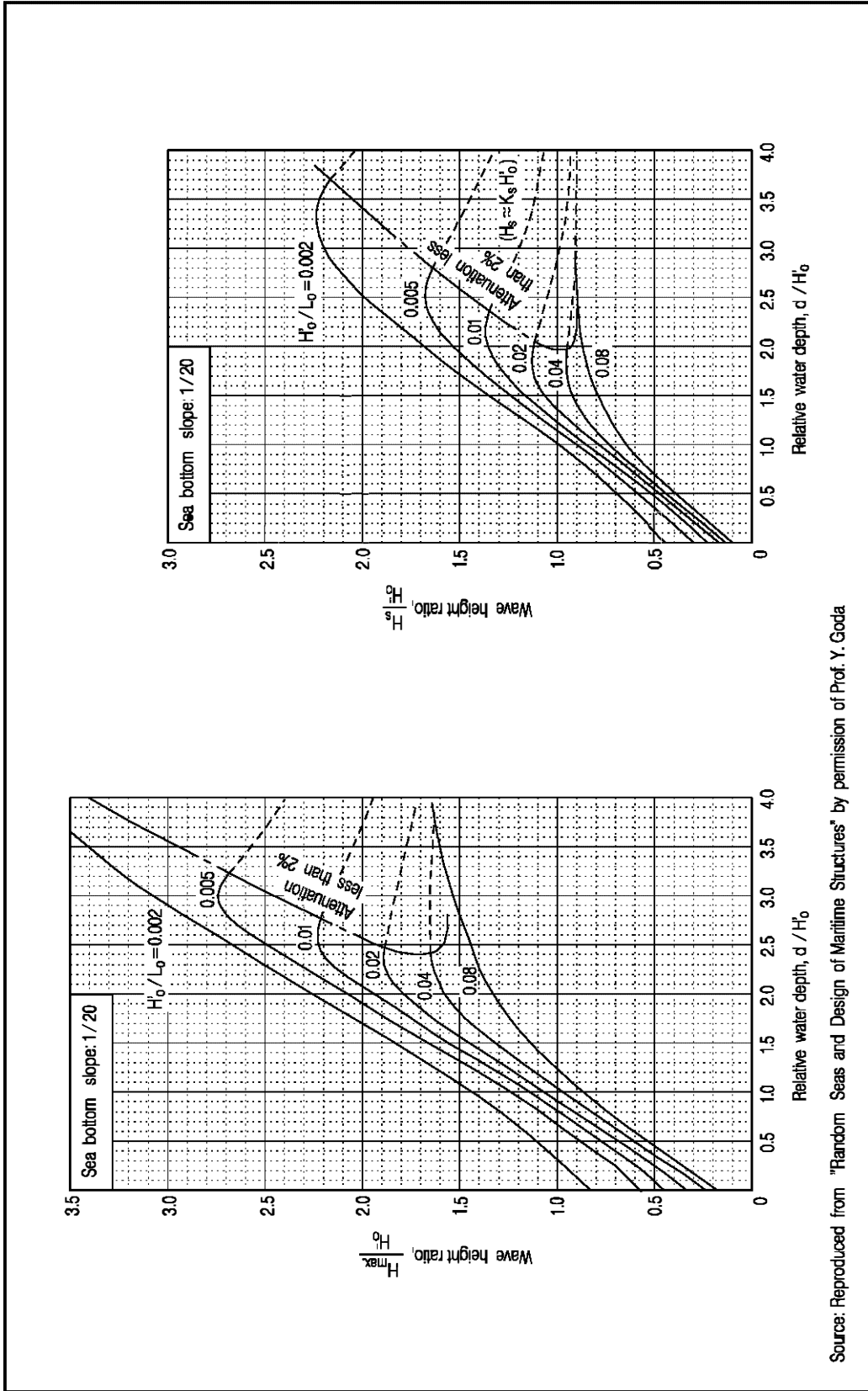

Figure A1 – Diagram of Nonlinear Wave Shoaling



Source: Reproduced from "Random Seas and Design of Maritime Structures" by permission of Prof. Y. Goda

Figure A2 – Estimation of Wave Height in the Surf Zone (Sheet 1 of 4)



Source: Reproduced from "Random Seas and Design of Maritime Structures" by permission of Prof. Y. Goda

Figure A2 – Estimation of Wave Height in the Surf Zone (Sheet 2 of 4)

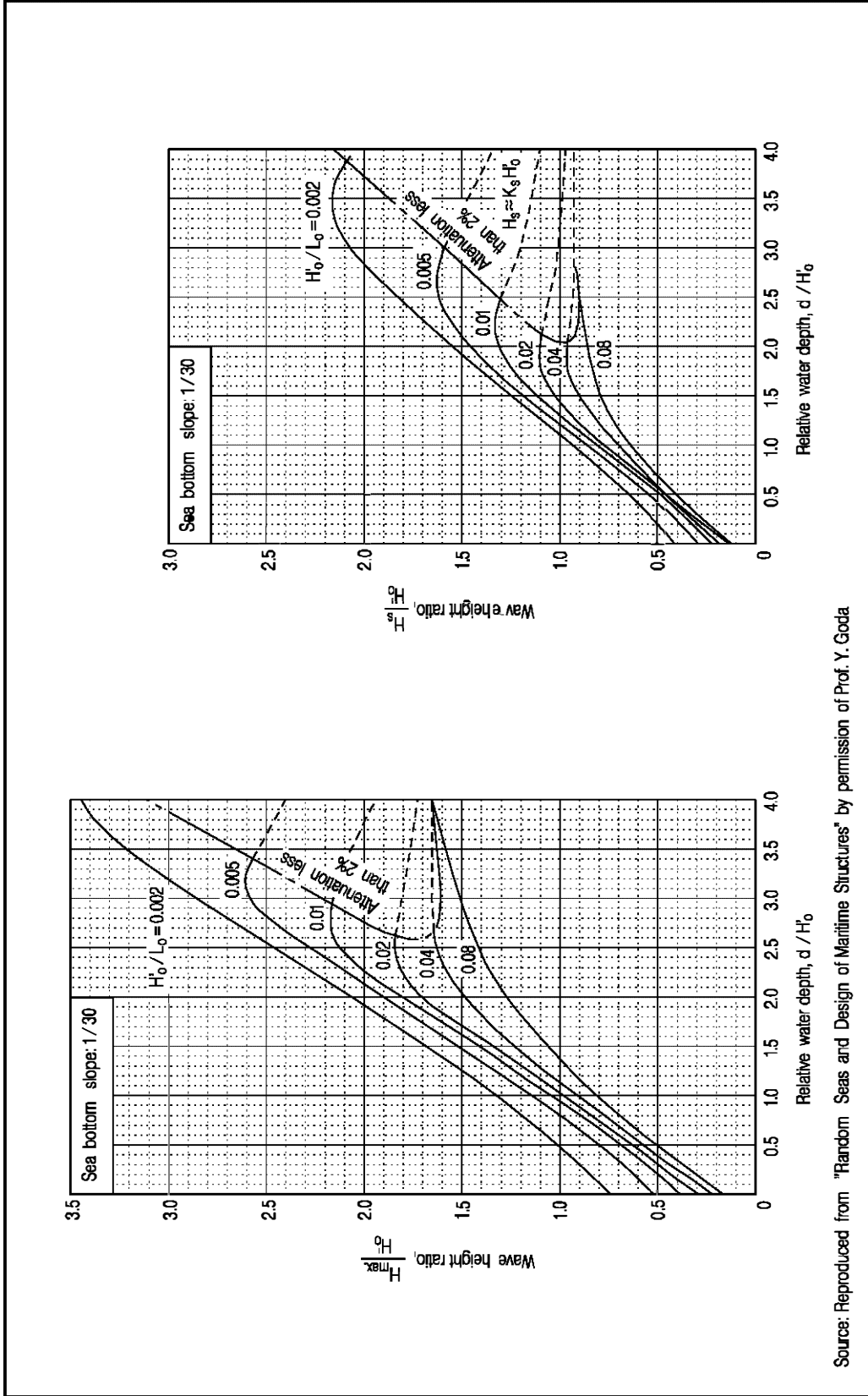

Source: Reproduced from "Random Seas and Design of Maritime Structures" by permission of Prof. Y. Goda

Figure A2 – Estimation of Wave Height in the Surf Zone (Sheet 3 of 4)

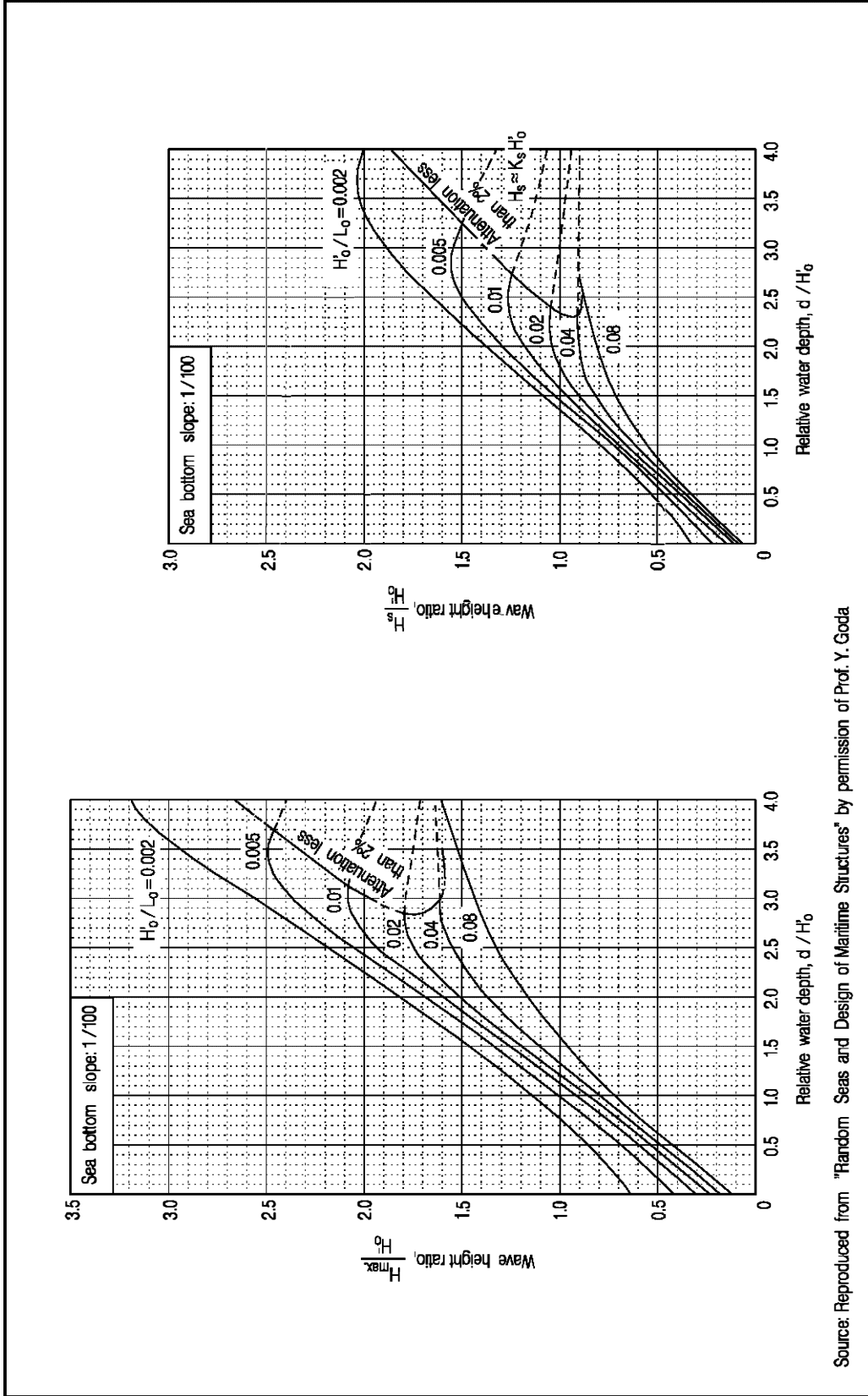

Source: Reproduced from "Random Seas and Design of Maritime Structures" by permission of Prof. Y. Goda

Figure A2 – Estimation of Wave Height in the Surf Zone (Sheet 4 of 4)

APPENDIX B

[Not used]

APPENDIX C

WORKED EXAMPLES

CONTENTS

	Page No.
TITLE PAGE	185
CONTENTS	187
C.1 WAVE HEIGHT AND PERIOD FROM SPECTRAL MOMENTS	189
C.2 GODA METHOD FOR BREAKING WAVES	190
C.3 WAVE FORCE ON VERTICAL BREAKWATER	192
C.4 WAVE FORCE ON VERTICAL SEAWALL	195
C.5 WAVE FORCE ON PILE	197
C.6 CURRENT FORCE ON PILE	199
C.7 BERTHING ENERGY AND FORCE	200
C.8 CALCULATION OF DESIGN WATER LEVEL	202
C.9 CALCULATION OF SEAWALL COPE LEVEL WITH CLIMATE RESILIENCE	203
LIST OF FIGURES	204

C.1 WAVE HEIGHT AND PERIOD FROM SPECTRAL MOMENTS

Reference Section 2.5.3.

Given

The wave measurement at 17:00 on 16.9.1999 at West Lamma Channel wave station gives the following wave spectrum information : $m_0 = 0.64 \text{ m}^2$, $m_2 = 0.82 \text{ m}^2/\text{s}^2$, $m_4 = 1.42 \text{ m}^2/\text{s}^4$, $T_p = 7.1 \text{ s}$, water depth = 10.5 m.

(Note : The outputs m_0 , m_2 and m_4 from the wave spectrum are expressed in w domain where $w = 2\pi f$ and f is the frequency)

Find

Spectral significant wave height H_{m0} , equivalent deepwater significant wave height H_o' and zero crossing period T_z .

Solution

$$H_{m0} = 4\sqrt{m_0} = 4\sqrt{0.64} = 3.2 \text{ m}$$

$$\frac{d}{L_o} = \frac{d}{1.56T_p^2} = \frac{10.5}{1.56 \times 7.1^2} = 0.133$$

From Figure A1 $K_s = 0.91$

Therefore $H_o' = H_{m0}/K_s = 3.2/0.91 = 3.5 \text{ m}$

Since the moments of the spectrum are expressed in w domain instead of frequency (f) domain, therefore, a factor of 2π has to be applied to the formula of T_z given in Section 2.5.3 :

$$T_z \approx 2\pi \sqrt{\frac{m_0}{m_2}} = 2\pi \sqrt{\frac{0.64}{0.82}} = 5.6 \text{ s}$$

C.2 GODA METHOD FOR BREAKING WAVES

Reference Section 2.5.9 and Appendix A.

Given

The significant wave height $H_{1/3}$ at a point about 50 m from the shore is found to be 2.7 m and the wave period is 7 s. The water depth at this point is 9 m and the slope of the seabed is 1 in 10.

Find

Estimate the wave height at a structure to be constructed at the shore where the water depth d is equal to 4 m.

Solution

Deepwater wavelength, $L_o = gT^2/2\pi = 1.56 \times (7)^2 = 76.4$ m

At the point of 50 m from the shore, water depth $d = 9.0$ m

$$d/L_o = 9.0/76.4 = 0.12$$

From Figure A1, $K_s = 0.91$

Equivalent deepwater water significant wave height $H_o' = H_{1/3}/K_s = 2.7/0.91 = 3.0$ m

(Since $H_{1/3} = K_s * K_r * K_r * K_d * H_o = K_s * H_o'$)

At the structure, water depth $d = 4.0$ m $> 0.5H_o'$ (equal $0.5 \times 3\text{m} = 1.5$ m), use $d = 4.0$ m

(see Appendix A Section A.4 last paragraph)

$$H_o'/L_o = 3.0/76.4 = 0.04$$

$$d/L_o = 4.0/76.4 = 0.052$$

From Figure A1, the intersection of H_o'/L_o and d/L_o is in the dotted line region and therefore the wave is breaking. The shoaling coefficient $K_s = 1.15$.

$H_{1/3}$ is the minimum of the following :

$$H_{1/3} = [0.028(H_o'/L_o)^{-0.38} \exp(20 \tan^{1.5} \theta)] H_o' + 0.52[\exp(4.2 \tan \theta)] d \quad \text{or}$$

$$H_{1/3} = H_o' \max\{0.92, 0.32(H_o'/L_o)^{-0.29} \exp(2.4 \tan \theta)\} \quad \text{or}$$

$$H_{1/3} = K_s H_o'$$

$$H_o' = 3.0 \text{ m}, L_o = 76.4 \text{ m}, d = 4.0 \text{ m}, \tan \theta = 1/10 = 0.1, K_s = 1.15$$

$$H_{1/3} = 3.7 \text{ or}$$

$$H_{1/3} = 3.1 \text{ or}$$

$$H_{1/3} = 3.5$$

Therefore, $H_{1/3} = 3.1 \text{ m}$

H_{\max} is the minimum of the following:

$$H_{\max} = [0.052(H_o'/L_o)^{-0.38} \exp(20 \tan^{1.5} \theta)] H_o' + 0.63[\exp(3.8 \tan \theta)] d \text{ or}$$

$$H_{\max} = H_o' \max\{1.65, 0.53(H_o'/L_o)^{-0.29} \exp(2.4 \tan \theta)\} \text{ or}$$

$$H_{\max} = 1.8 K_s H_o'$$

$$H_{\max} = 4.7 \text{ or}$$

$$H_{\max} = 5.1 \text{ or}$$

$$H_{\max} = 6.2$$

Therefore, $H_{\max} = 4.7 \text{ m}$

C.3 WAVE FORCE ON VERTICAL BREAKWATER

Reference Section 5.10.3(1).

Given

See Figure C1 on dimensions of vertical breakwater.

Water depth at structure $d = 11.5$ m (the structure is seaward of the surf zone)

Water depth measured to the top of toe protection $d_m = 9.5$ m

Water depth measured to the bottom of toe protection $d' = 10.1$ m

Base width of structure = 15 m

At extreme water level, height of crest above water level $h_c = 0.8$ m

Significant wave height $H_{1/3} = 2.0$ m

Wave period $T = 4.0$ s

Angle between the direction of wave approach and the normal of the structure = 5°

Density of seawater = 1025 kg/m^3

Find

Estimate the wave force, the hydrostatic and buoyancy forces on the structure.

Solution

Design wave height $H_D = H_{\max} = 1.8H_{1/3} = 1.8 \times 2.0 = 3.6$ m

(If the location of vertical structures is inside the surf zone, H_{\max} may be determined according to Appendix A.)

Wavelength at the structure, $L = 24.6$ m (solved by $L = \frac{gT^2}{2\pi} \tanh kd$, $k = 2\pi/L$)

Local depth of water at a distance $5H_{1/3}$ seaward of the structure $d_b = 13.5$ m (from sounding survey plan)

Critical condition occurs when the wave crest is at the seaward side of the structure and there is no wave in the harbour side. Therefore, use Goda wave pressure formulae.

$$d/L = 11.5/24.6 = 0.47$$

$$d_m/d_b = 9.5/13.5 = 0.70$$

$$H_D/d_m = 3.6/9.5 = 0.38$$

$$d'/d = 10.1/11.5 = 0.88$$

From figure 16

$$\alpha_1 = 0.6$$

$$\alpha_2 = 0.015$$

$$\alpha_3 = 0.21$$

Since the angle between the direction of wave approach and a line normal to the structure is less than 15° , therefore $\beta = 0^\circ$

The elevation to which wave pressure is exerted :

$$\begin{aligned}\eta^* &= 0.75(1 + \cos \beta)H_D \\ &= 0.75 \times (1.0 + 0) \times 3.6 \\ &= 2.7 \text{ m}\end{aligned}$$

Wave pressure on the front face of the structure :

$$\begin{aligned}p_{w1} &= \frac{1}{2}(1 + \cos \beta)(\alpha_1 + \alpha_2 \cos^2 \beta)\gamma_w H_D \\ &= 0.5(1.0 + 0)(0.6 + 0.015)(10.06)3.6 \\ &= 11.1 \text{ kN/m}^2\end{aligned}$$

$$\begin{aligned}p_{w2} &= \alpha_3 p_{w1} \\ &= 0.21(11.1) \\ &= 2.3 \text{ kN/m}^2\end{aligned}$$

Uplift pressure at the toe of the structure :

$$\begin{aligned}p_u &= \frac{1}{2}\alpha_1\alpha_3(1 + \cos \beta)\gamma_w H_D \\ &= 0.5 \times 0.6 \times 0.21(1.0 + 0)(10.06)3.6 \\ &= 2.3 \text{ kN/m}^2\end{aligned}$$

The force diagram is shown in Figure C1. The Goda wave formulae do not include the hydrostatic and buoyancy components.

Horizontal force due to wave pressure

$$= (11.1 + 2.3) \times 10.1/2 + (11.1 + 7.8) \times 0.8/2 = 75.2 \text{ kN/m} \quad (\text{direction toward harbour side})$$

Uplift due to wave pressure

$$= 2.3 \times 15/2 = 17.3 \text{ kN/m}$$

Uplift due to buoyancy

$$= 1.025 \times 9.81 \times 10.1 \times 15.0 = 1523.4 \text{ kN/m}$$

Note :

According to Goda (2000), the wave pressure originates from the difference between the quasi-hydrostatic pressures acting at the front and rear of an upright section. The quasi-hydrostatic pressure in front of an upright wall is slightly less than the hydrostatic pressure corresponding to the water level of wave crest. Therefore, there is no need to add the hydrostatic head between the front and rear of an upright section.

C.4 WAVE FORCE ON VERTICAL SEAWALL

Reference Section 5.10.3(2).

Given

See Figure C2 on dimensions of vertical seawall.

Water depth at structure $d = 11.5$ m

Base width of structure = 10.0 m

Rise of water level behind seawall above still water level $d' - d = 1.0$ m

Significant wave height $H_{1/3} = 2.0$ m

Wave period $T = 4.0$ s

Density of seawater = 1025 kg/m³

Find

Estimate the wave force, the hydrostatic and buoyancy forces on the structure.

Solution

Design wave height $H_D = H_{\max} = 1.8H_{1/3} = 1.8 \times 2.0 = 3.6$ m

(It can be checked from Appendix A that wave breaking does not occur at the structure)

Wavelength at the structure, $L = 24.6$ m (solved by $L = \frac{gT^2}{2\pi} \tanh kd$, $k = 2\pi/L$)

$$d/L = 11.5/24.6 = 0.47$$

Critical condition occurs when the wave trough is at front face of the seawall. Therefore, use Sainflou wave pressure formulae.

Clapotis set-up,

$$H_{OC} = \frac{\pi H_D^2}{L} \coth(2\pi d/L) = \frac{\pi 3.6^2}{24.6} \coth(2\pi \times 0.47) = 1.66 \text{ m}$$

Pressure at the toe of the structure :

$$\begin{aligned} p_{\min} &= \gamma_w d - \gamma_w H_D / \cosh(2\pi d/L) \\ &= 10.06(11.5) - 10.06(3.6) / \cosh(2\pi \times 0.47) = 111.9 \text{ kN/m}^2 \end{aligned}$$

The force diagram is shown in Figure C2. The Sainflou wave formulae have included the hydrostatic and buoyancy components.

Hydrostatic pressure at the heel of the structure

$$\gamma_w d' = 10.06 \times 12.5 = 125.8 \text{ kN/m}^2$$

Horizontal force due to wave and hydrostatic pressure on front vertical face of seawall

$$= 111.9 \times (11.5 - 1.94)/2 = 534.9 \text{ kN/m} \quad (\text{direction toward land side})$$

Horizontal force due to hydrostatic pressure on back of the seawall

$$= 125.8 \times (11.5 + 1.0)/2 = 786.3 \text{ kN/m} \quad (\text{seaward direction})$$

Uplift due to wave pressure and buoyancy

$$= (111.9 + 125.8) \times 10.0/2 = 1188.5 \text{ kN/m}$$

C.5 WAVE FORCE ON PILE

Reference Section 5.10.4.

Given

See Figure C3

Diameter of vertical piles of a suspended deck pier = 600 mm

Pile spacing = 4.0 m

Water depth at structure $d = 6.5$ m

Significant wave height $H_{1/3} = 1.45$ m

Wave period = 7 s (corresponding wavelength $L = 51$ m)

Kinematic viscosity $\nu = 1.0$ mm²/s for 20° water temperature

Density of seawater = 1025 kg/m³

Find

Wave force on the piles.

Solution

$$H_D = 2 H_{1/3} = 2 \times 1.45 = 2.9 \text{ m}$$

(It can be checked from Appendix A that wave breaking does not occur at the structure.)

$$d/L = 6.5/51 = 0.127$$

$$W_p = \frac{H_D}{\tanh\left(\frac{2\pi d}{L}\right)} = 2.9/\tanh(2\pi \times 0.127) = 4.3 \text{ m}$$

$$\text{Pile diameter with marine growth (100mm) } D = 0.6 + 2 \times 0.1 = 0.8 \text{ m}$$

$$D/W_p = 0.8/4.3 = 0.186 < 0.2$$

Therefore, drag force is dominant.

The order of the horizontal water particle velocity normal to member may be estimated from the following equation (see BS6349-Part1:2000) :

$$U_{\max} = \frac{\pi H}{T} \frac{\cosh[2\pi(z+d)/L]}{\sinh(2\pi d/L)}$$

At $z = 0$, $U_{\max} = (\pi \times 2.9/7) \times \coth(2\pi \times 6.5/51) = 2 \text{ m/s}$

Reynolds number $Re = UD/\nu = (2.0 \times 0.8)/(1.0 \times 10^{-6}) = 1.6 \times 10^6$

From Figure 19, for rough cylinder, drag coefficient $C_D = 1.0$

From Figure 18 and Figure C3,

Wave force on a vertical pile when the wave crest is at the pile :

$$= 1.4 \times \sum_i \frac{C_D \rho g D H^2}{2} \left\{ \frac{g T^2}{4 L^2} \left[\frac{\cosh[2\pi(z+d)/L]}{\cosh[2\pi d/L]} \right]^2 \right\} \Delta z \quad i = 1 \text{ to } 8, \Delta z = 1.0 \text{ m}$$

i	z (m)	Z+d (m)	{cosh[2 π (z+d)/L]} ²
1	1	7.5	2.13
2	0	6.5	1.79
3	-1	5.5	1.53
4	-2	4.5	1.34
5	-3	3.5	1.20
6	-4	2.5	1.10
7	-5	1.5	1.03
8	-6	0.5	1.00

Total 11.12

Substitute $D = 0.8 \text{ m}$, $C_D = 1.0$, $H_D = 2.9 \text{ m}$, $d = 6.5 \text{ m}$, $L = 51 \text{ m}$, $\rho = 1025 \text{ kg/m}^3$,
 $g = 9.81 \text{ m/s}^2$

Wave force on a vertical pile = 13638 N = 13.6 kN

Pile spacing = 4.0 m > 2 x pile diameter (i.e. 2 x 0.6 m = 1.2 m)

Therefore, it is not necessary to increase the wave load on the front piles by the factors given in Section 5.10.4.

C.6 CURRENT FORCE ON PILE

Reference Section 5.11.2.

Given

Diameter of vertical piles of a suspended deck pier = 800 mm

Water depth at structure = 10 m

Velocity of current = 1.0 m/s

Kinematics viscosity $\nu = 1.0 \text{ mm}^2/\text{s}$ for 20° water temperature

Density of seawater = 1025 kg/m^3

Find

Current force on pile.

Solution

Pile diameter with marine growth (100mm) = $0.8 + 2 \times 0.1 = 1.0 \text{ m}$

Reynolds number $Re = UD/\nu = (1.0 \times 1.0)/(1.0 \times 10^{-6}) = 1.0 \times 10^6$

From Figure 19, drag coefficient for rough cylinder $C_D = 1.0$

From Section 5.11.2

$$\begin{aligned} \text{Steady drag force per unit length of pile } f_D &= \frac{1}{2} C_D \rho v^2 D = 0.5(1.0)(1025)(1.0)^2(1.0) \\ &= 513 \text{ N/m} \end{aligned}$$

Total force on each pile = $513 \text{ N/m} \times 10 \text{ m} = 5.1 \text{ kN}$

The force can be assumed acting uniformly over the pile length.

C.7 BERTHING ENERGY AND FORCE

Reference Section 5.12.

Given

Type of structure = solid jetty

Draft of vessel $D_v = 4.5$ m

Beam of vessel $B_v = 9.0$ m

Length of the hull between perpendiculars $L_v = 43$ m

Displacement of the vessel $M_v = 600$ tonnes

Distance of the point of contact from the centre of mass, $R_v = 18$ m

Angle between the line joining the point of contact to the centre of mass and the velocity vector $\gamma = 45^\circ$

Find

Energy absorption capacity of rubber fender and berthing reaction.

Solution

From Section 5.12.2 (1)

Berthing velocity normal to berth $V_b = 0.3$ m/s

From Section 5.12.2 (2)

$$C_m = 1 + 2(D_v/B_v) = 1 + 2 \times (4.5/9) = 2.0$$

From Section 5.12.2 (3)

$$C_e = (K_v^2 + R_v^2 \cos^2 \gamma) / (K_v^2 + R_v^2) = (7.5^2 + 18.0^2 \cos^2 45) / (7.5^2 + 18.0^2) = 0.57$$

where $K_v = [0.19 \times 600 \times 10^3 / (43 \times 9.0 \times 4.5 \times 1025) + 0.11] \times 43 = 7.5$ m

From Section 5.12.2 (4),

Since no reliable information is available for the vessel's hull, C_s is taken as 1.0.

From Section 5.12.2 (5),

The berth configuration coefficient, C_c is taken as 0.9 for solid structure.

$$\text{Berthing Energy } E = \frac{1}{2} C_m M_v V_b^2 C_e C_s C_c = 0.5(2 \times 600 \times 0.3^2 \times 0.57 \times 1.0 \times 0.9) = 28 \text{ kNm}$$

From Section 5.12.2(1), the total energy to be absorbed for accident loading should be at least 50% greater than that for normal loading.

Therefore, select a fender from supplier catalogue with designed energy absorption capacity greater than $28 \times 1.5 = 42$ kNm .

The berthing reaction is estimated as follows :

For normal loading condition, the berthing reaction can be read from the performance curve of the selected fender corresponding to berthing energy of 28 kNm.

For accident loading condition, the berthing reaction can be read from the performance curve of the selected fender corresponding to berthing energy of 42 kNm.

The relationship between berthing energy and reaction is shown in Figure C4.

C.8 CALCULATION OF DESIGN WATER LEVEL

Reference Sections 2.2.4, 2.2.5 and 2.2.6.

Given

A seawall located in the Inner Victoria Harbour is designed for use up to 2090.

Find

The 100-year and 10-year design water levels for checking seawall stability or overtopping under the combination of hydraulic conditions for an extreme event of about 100 years.

Solution

For a conservative design, return period of storm surge increase shall follow the return period of wave.

100-year design water level

100-year design water level = 100-year extreme sea level + sea level rise + 10-year storm surge increase

From Table 4, the 100-year extreme sea level at Quarry Bay / North Point is 3.91mPD.

From Table 42, the rise in sea level due to climate change for 2090 is 0.47m.

From Table 44, the 10-year storm surge increase at Quarry Bay / North Point for 2090 is 0.10m.

The 100-year design water level = 3.91mPD + 0.47m + 0.10m = 4.48 mPD

10-year design water level

10-year design water level = 10-year extreme sea level + sea level rise + 100-year storm surge increase

From Table 4, the 10-year extreme sea level at Quarry Bay / North Point is 3.20mPD.

From Table 42, the rise in sea level due to climate change for 2090 is 0.47m.

From Table 44, the 100-year storm surge increase for 2090 is 0.16m.

The 10-year design water level = 3.20mPD + 0.47m + 0.16m = 3.83 mPD

C.9 CALCULATION OF SEAWALL COPE LEVEL WITH CLIMATE RESILIENCE

Reference Section 2.9

Given

A vertical seawall located in the Inner Victoria Harbour has been designed to cater for wave, sea level and storm surge increase conditions with climate change effect up to 2090, after taking into account the relevant parameters given in Tables 3 to 30F and Tables 42 to 44. The minimum cope level is calculated to be +5.5mPD with paved land behind.

Find

If the land behind is unpaved in nature, the required design cope level of the seawall with climate resilience.

Solution

From Section 2.9, to further enhance the resilience against climate change for new coastal structures against possible higher Greenhouse Gas emissions scenarios, the design allowance shall be added to the design of marine works, unless infeasible.

From Table 45, a design allowance value can be chosen based on location and time horizon. Quarry Bay / North Point location provides the most representative conditions of Inner Victoria Harbour.

From Table 45, the design allowance at Quarry Bay / North Point in 2090 for 100-year return period event for paved land behind the structure = $0.24\text{m} + 0.18\text{m} = 0.42\text{m}$.

Since the land behind is unpaved in nature, an additional figure of 0.05m is required to be added so the design allowance = $0.42\text{m} + 0.05\text{m} = 0.47\text{m}$.

The design cope level for the seawall is $+5.5\text{mPD} + 0.47\text{m} = +5.97\text{ mPD}$.

LIST OF FIGURES

Figure No.		Page No.
C1	Wave Force on Vertical Breakwater	206
C2	Wave Force on Vertical Seawall	207
C3	Wave Force on Vertical Pile	208
C4	Fender Performance Curve	209

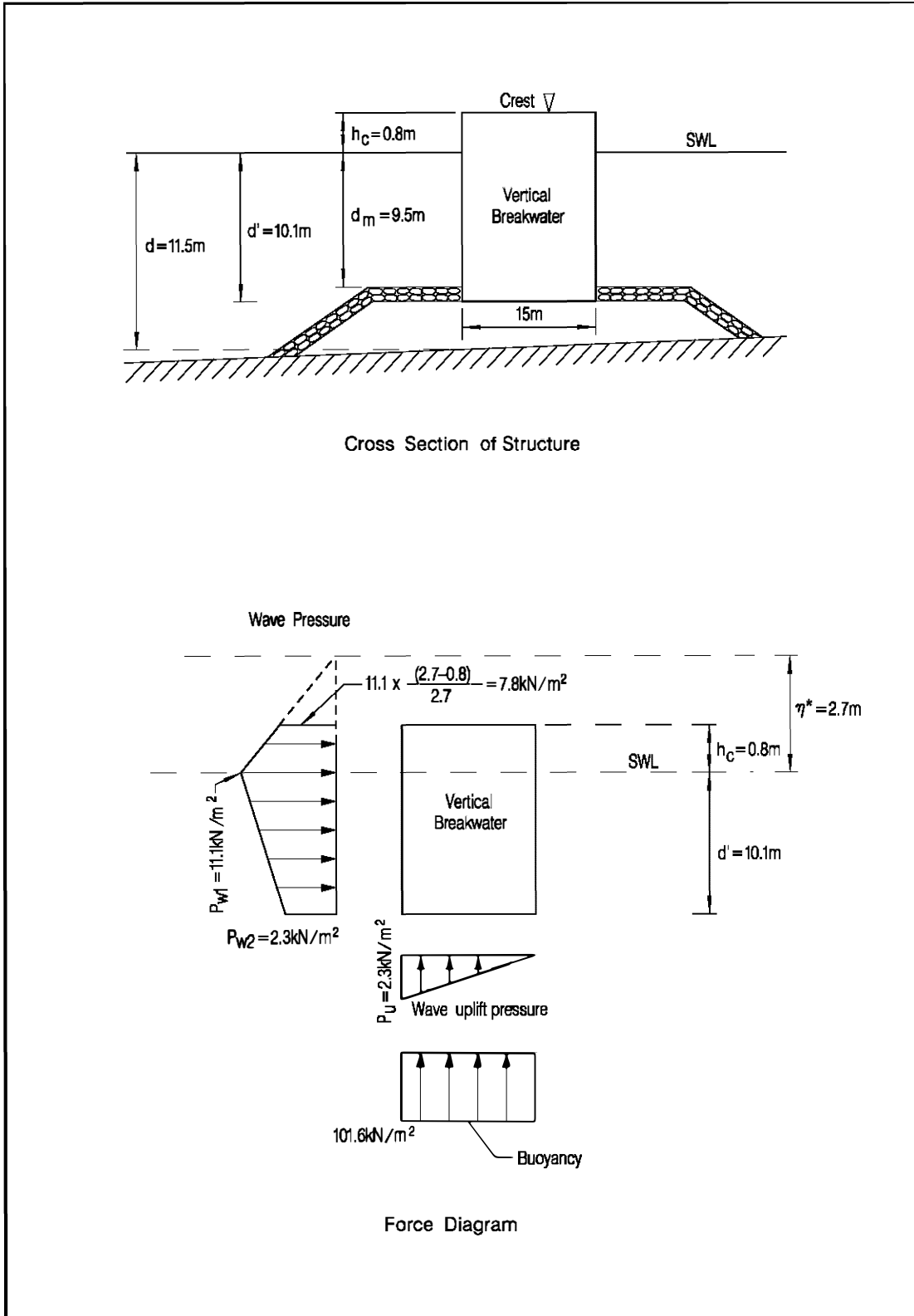

Figure C1 – Wave Force on Vertical Breakwater

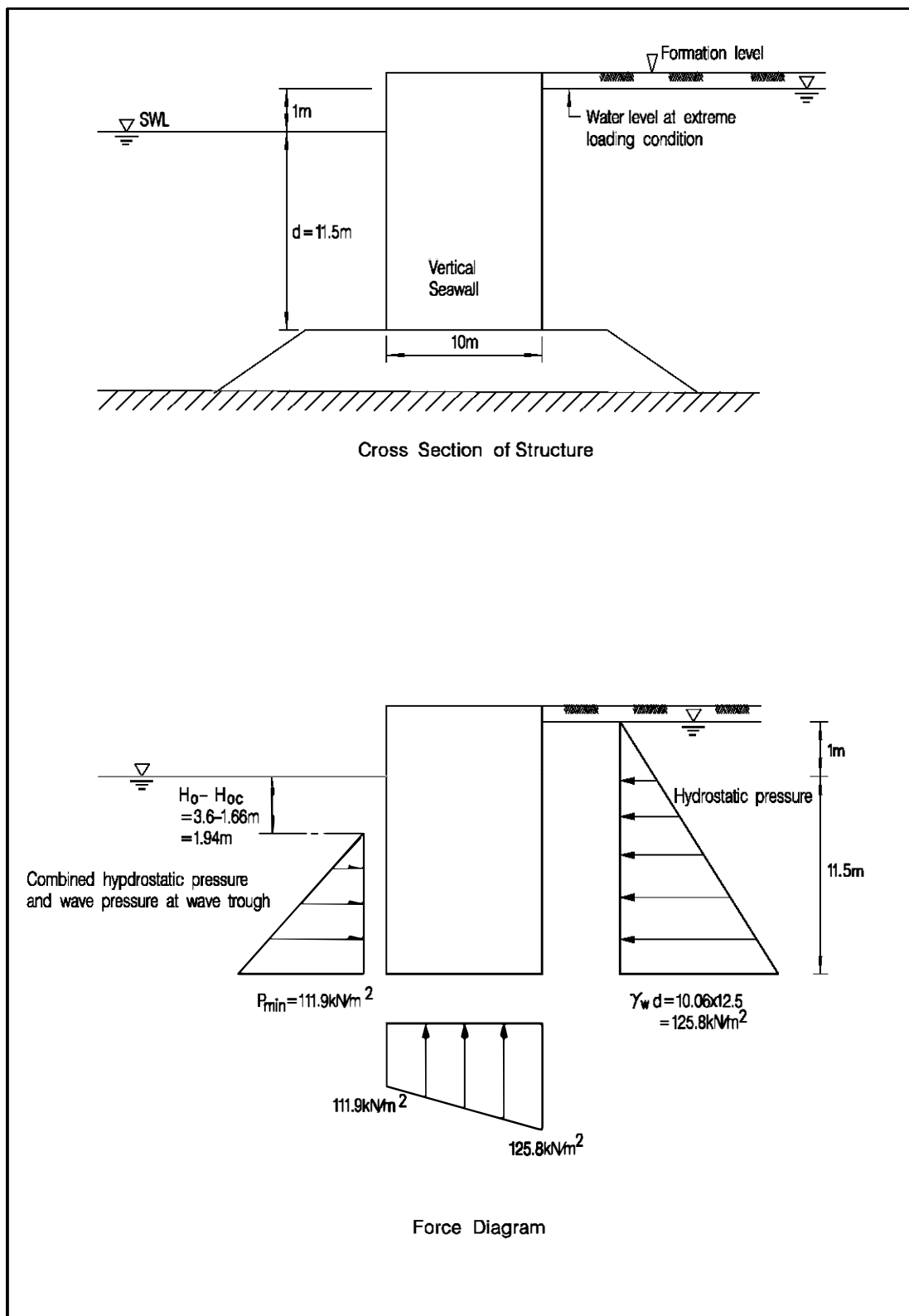

Figure C2 – Wave Force on Vertical Seawall

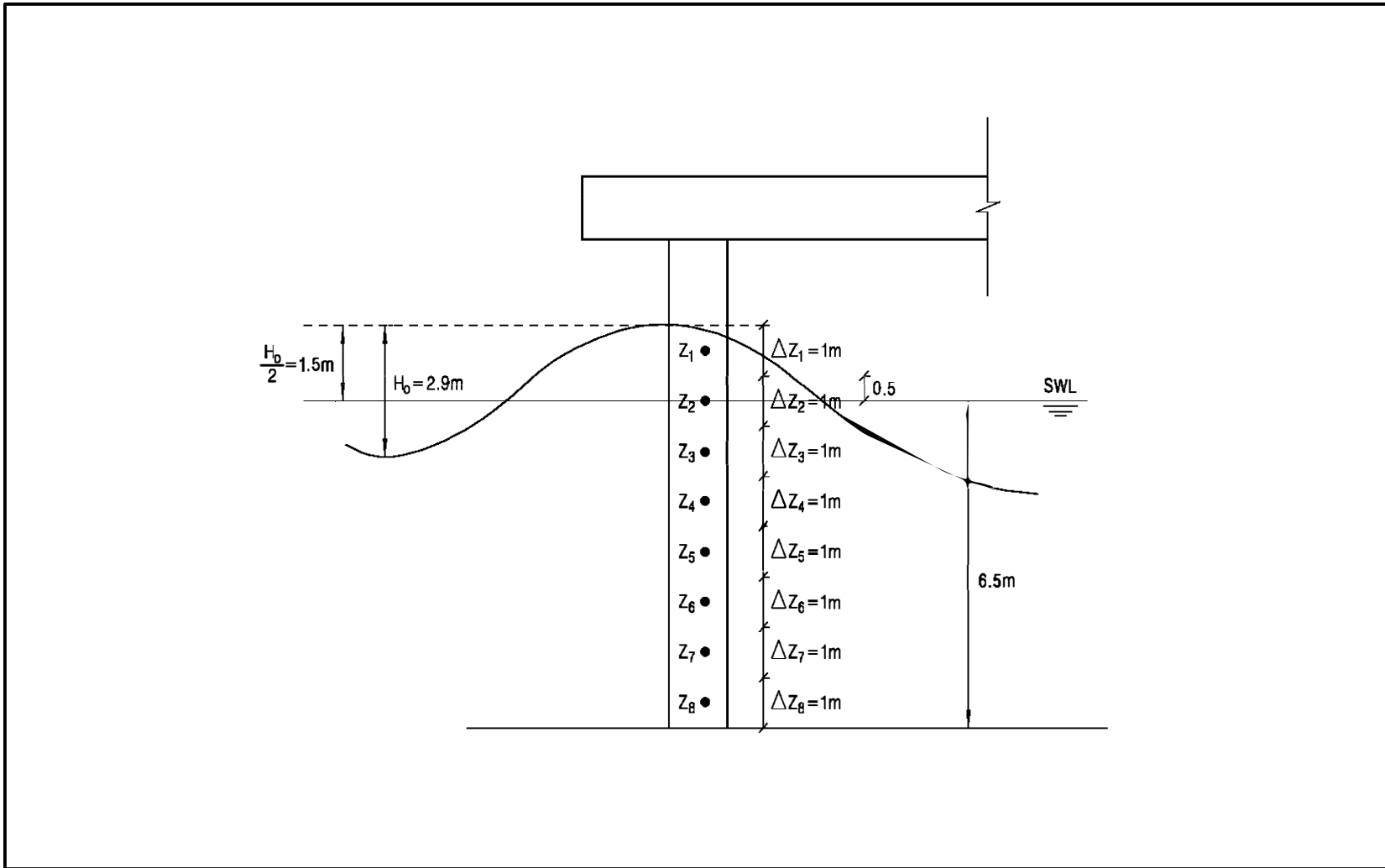

Figure C3 – Wave Force on Vertical Pile

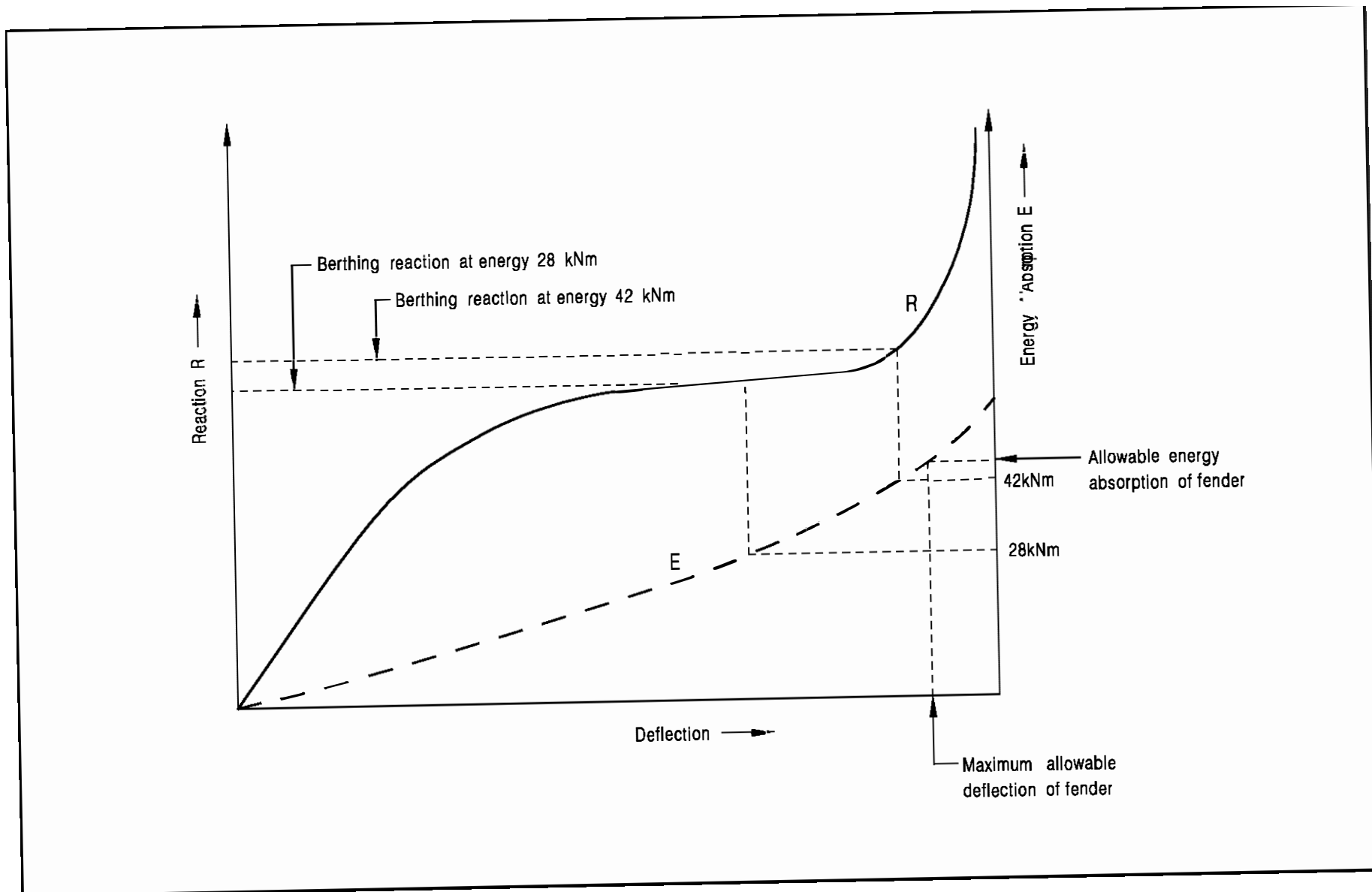

Figure C4 – Fender Performance Curve

APPENDIX D

**REFERENCE EXTREME SEA LEVELS
AT QUARRY BAY/NORTH POINT AND TAI PO KAU**

CONTENTS

	Page No.
TITLE PAGE	210
CONTENTS	211
D.1 GENERAL	212

D.1 GENERAL

For design of important facilities which are vulnerable and sensitive to sea water level, e.g. E&M installations, designers may take into account the historical storm surge records before 1954 as far as practicable.

This Appendix provides the extreme sea levels at North Point/ Quarry Bay and Tai Po Kau derived from frequency analysis of extreme sea levels with longer data periods including pre-1954 records in tabular form and graphical form with 95% confidence interval curves as follows:

Table D1 Extreme Sea Levels at Quarry Bay / North Point with pre-1954 records (1874-2019)

Return Periods (years)	Sea Level (mPD)
2	2.81
5	3.03
10	3.20
20	3.41
50	3.74
100	4.05
200	4.42

Note: Tide gauge data period is (1954-2019). Historical records for significant storm surge events in 1874, 1923, 1936, 1937, 1949 and 1951 are included for analysis. Missing data are imputed by bootstrapping tide gauge tide below 3.15 mPD. The extreme sea levels at Quarry Bay/North Point were based on frequency analysis of non-instrumental data and instrumental data from 1874 to 2019 and adjusted by +0.07m to AR6 base year (1995-2014).

Table D2 Extreme Sea Levels at Tai Po Kau with pre-1954 records (1874-2019)

Return Periods (years)	Sea Level (mPD)
2	2.96
5	3.26
10	3.55
20	3.93
50	4.62
100	5.34
200	6.30

Note: Tide gauge data period is (1962-2019). Historical records for significant storm surge events in 1874, 1923, 1936 and 1937 are included for analysis. Missing data are imputed by bootstrapping below 3.55 mPD. The extreme sea levels at Tai Po Kau were based on frequency analysis of non-instrumental data and instrumental data from 1874 to 2019 and adjusted by +0.04m to AR6 base year (1995-2014).

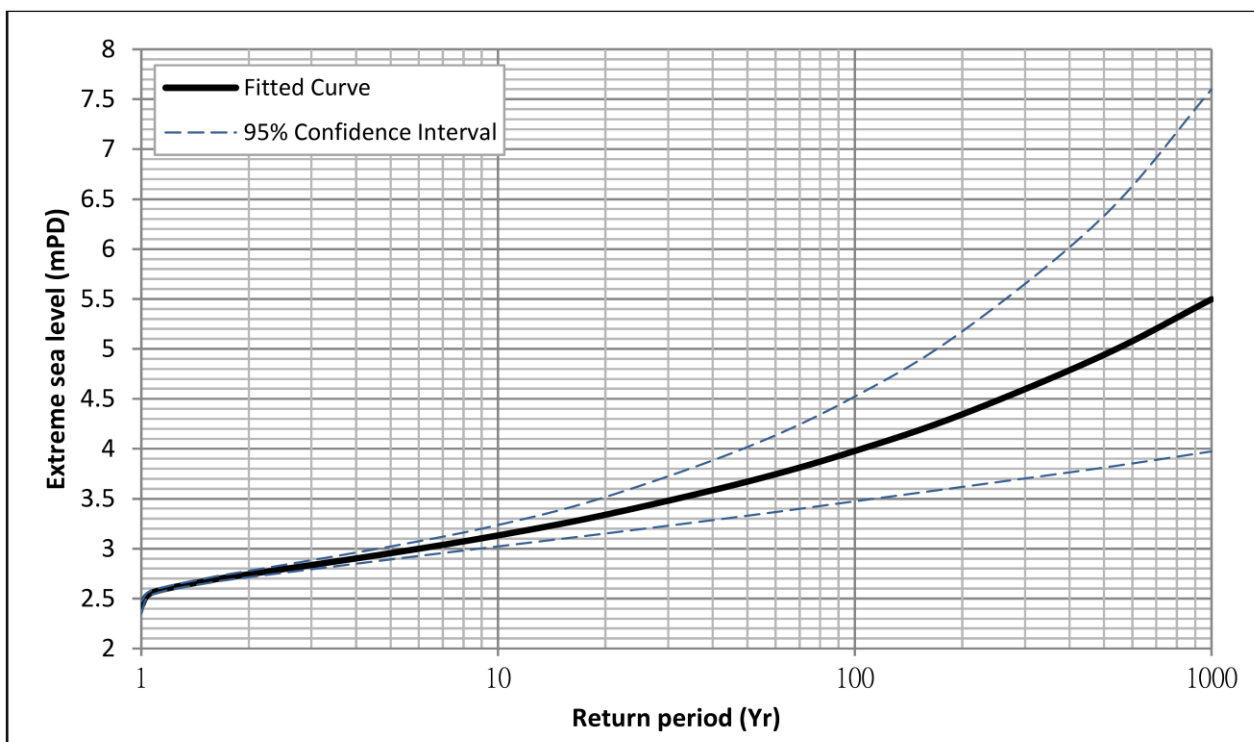

Figure D1 Extreme Sea Levels at Quarry Bay / North Point with pre-1954 records (1874-2019)

Note: For adopting the data of this figure, the user shall make adjustment to AR6 base year (1995-2014) by adding +0.07m of the data read in this figure.

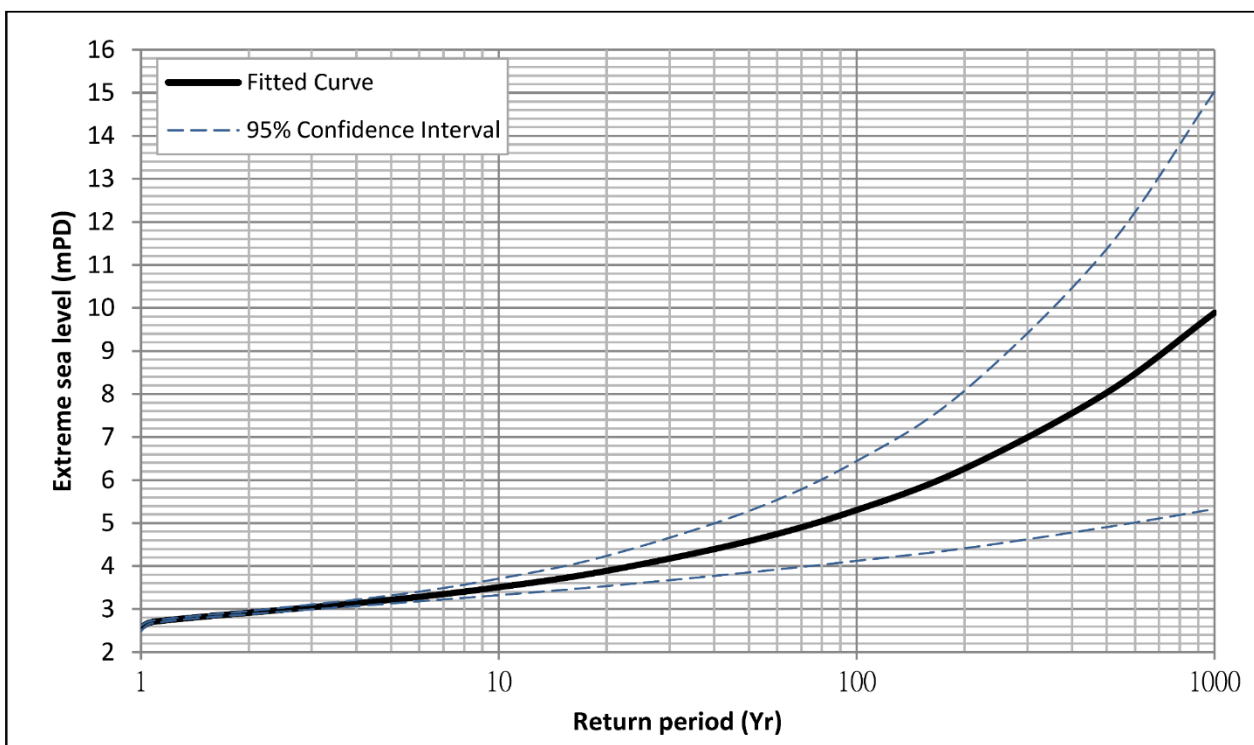

Figure D2 Extreme Sea Levels at Tai Po Kau with pre-1954 records (1874-2019)

Note: For adopting the data of this figure, the user shall make adjustment to AR6 base year (1995-2014) by adding +0.04m of the data read in this figure.

GLOSSARY OF TERMS AND SYMBOLS

GLOSSARY OF TERMS

Beam. The maximum breadth of a vessel.

Diurnal tides. A tidal pattern in which there are one high tide and one low tide in a day.

Draft. The depth of a vessel below the waterline measured vertically to the vessel's base line or keel.

Fetch distance. The distance over which the wind blows.

Fully loaded displacement. The maximum displacement of a vessel measured in tonnage when floating at its greatest allowable draft.

Quaternary. The Quaternary is the shortest and most recent geological period in the Earth's history, spanning the period about 1.61 million years ago until the present day.

High tide. The maximum height reached in a rising tide.

Length overall. The extreme length of a vessel measured from the foremost point of the stem to the aftermost part of the stem.

Light displacement. The minimum displacement of a vessel.

Low tide. The minimum height reached in a falling tide.

Lowest astronomical tide. The lowest level that can be predicted to occur under average meteorological conditions and under any combination of astronomical conditions.

Neap tides. Tides of small range occur when the moon is at its first or last quarter.

Phase velocity. The speed at which a wave propagates.

Semi-diurnal tide. A tidal pattern in which there are two high tides and two low tides in a day.

Splash zone. The zone from the high water level to the upper levels attained by spray of seawater and subject to intermittent wetting and drying as waves run up or break on

the structure.

Spring tides. Semi-diurnal tides of large range occur when the moon is new or full.

Tidal range. The difference in height between a high tide and the succeeding or preceding low tide.

Tidal zone. The usual range between high and low water which is periodically immersed.

Wavelength. The distance between successive crests of the wave.

Wave height. The vertical distance between the crest and successive trough of the wave.

Wave overtopping. Over-spilling of water of waves when the crest level of the structure is lower than the wave run-up level.

Wave period. The time required for the passage of successive crests.

Wave spectrum. The expression of the distribution of wave energy against the wave frequency.

GLOSSARY OF SYMBOLS

B_v	Beam of vessel
C_D	Drag coefficient
C_I	Inertia coefficient
C_c	Berth configuration coefficient
C_e	Eccentricity coefficient
C_m	Hydrodynamic coefficient
C_s	Softness coefficient
D	Pile diameter
D_v	Draft of vessel
d	Water depth
E	Berthing energy
f_D	Drag force per unit length
f_i	Inertia force per unit length
g	Acceleration due to gravity
$H_{1/3}$	Significant wave height, also denoted as H_s in other literatures
H_D	Design wave height
H_{max}	Maximum wave height
H_{m0}	Spectral significant wave height determined from a wave spectrum
H_o	Deep water significant wave height
H_o'	Equivalent deep water significant wave height
K_v	Radius of gyration of vessel.
L	Wavelength
L_o	Wavelength in deepwater
L_v	Length of hull between perpendiculars of vessel
M_v	Displacement of vessel
m_i	The i -th moment of the wave spectrum, $i = 0, 1, 2, 3, 4, \dots$

R	Berthing reaction
R_v	Distance between the point of contact of vessel at the berth from its centre of mass
T	Wave period
$T_{1/3}$	Significant wave period, also denoted as T_s in other literatures
T_{max}	The period of the maximum wave height
T_p	Peak wave period
T_R	Return period
T_z	Zero crossing wave period
t_u	Duration of wind
u	Wind speed
V_b	Velocity of the vessel normal to the berth
v	Velocity of current
v_c	Phase velocity
X	Fetch distance
ρ	Density of water
γ_w	Unit weight of water
θ	Slope of seabed